

O uso da tecnologia DWDM em redes de provedores de internet

Fabrício Marchiori
Marketing de Produto
mktproduto@padtec.com.br

Padtec

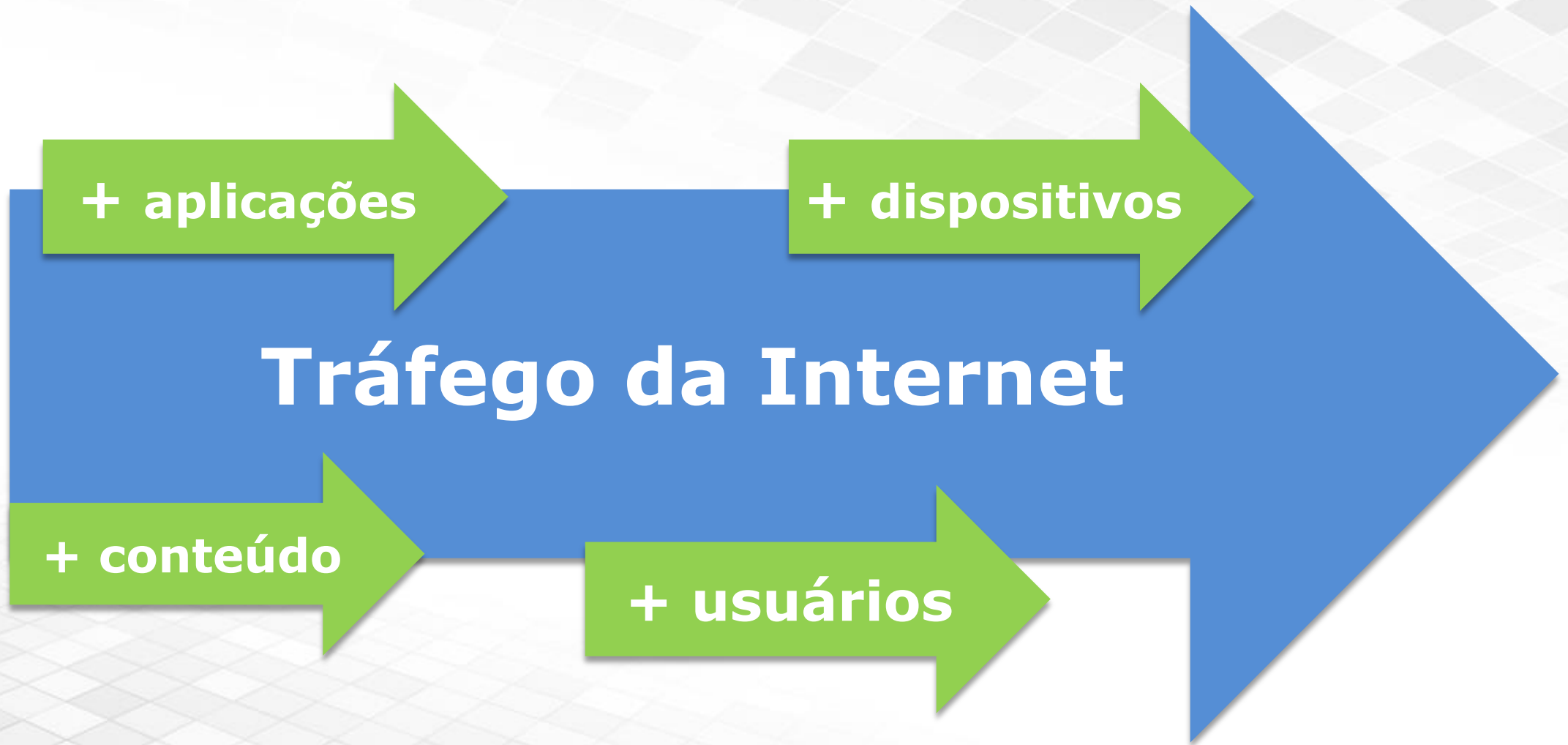

Queremos sempre mais...

Cenário:

- *IoT*
- *M2M*
- *Big Data*
- *Vídeo (HD, 4k...)*
- *Dispositivos Móveis*
- *Gaming*

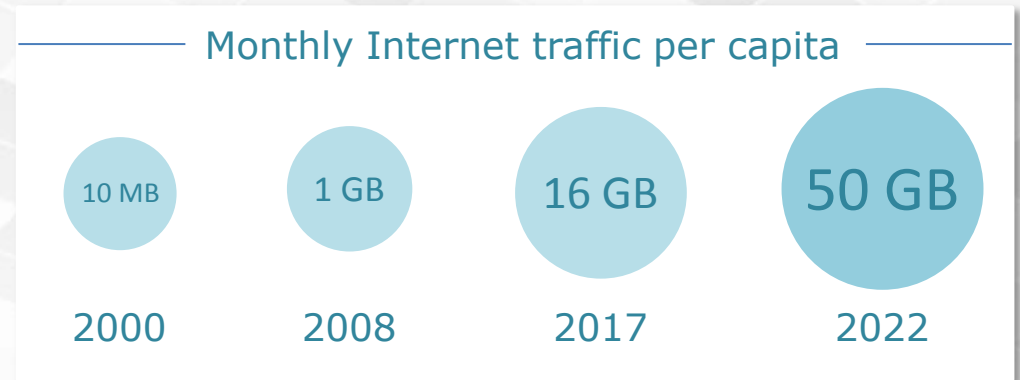

Internet Users: % of Population (Global)

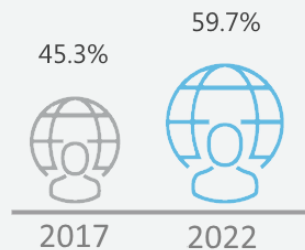

Billions of Devices

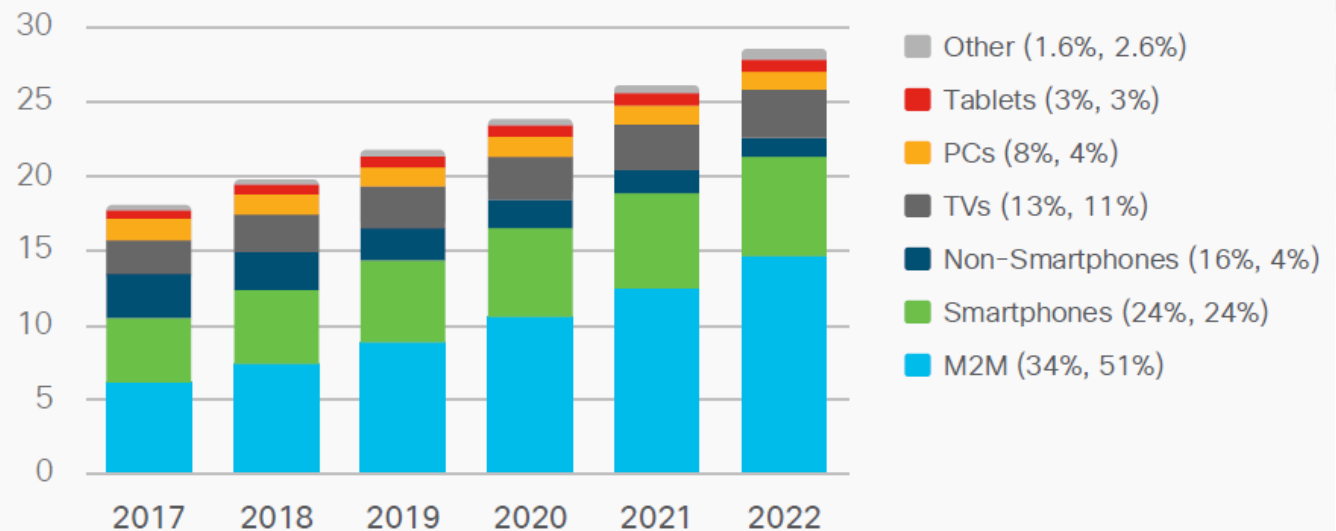

Figures (n) refer to 2017, 2022 device share

Source: Cisco VNI Global IP Traffic Forecast, 2017-2022

Média da Velocidade de Conexão

Fonte: Akamai | State of The Internet Q1 2017 Report

Global Rank	Country/Region	Q1 2017 Avg. Mbps
10	United States	18.7
20	Canada	16.2
57	Uruguay	9.5
60	Chile	9.3
76	Mexico	7.5
79	Brazil	6.8
90	Argentina	6.3
91	Peru	6.2
92	Ecuador	6.2
94	Panama	5.9
99	Colombia	5.5
112	Costa Rica	4.1
132	Bolivia	2.7
144	Venezuela	1.8
148	Paraguay	1.4

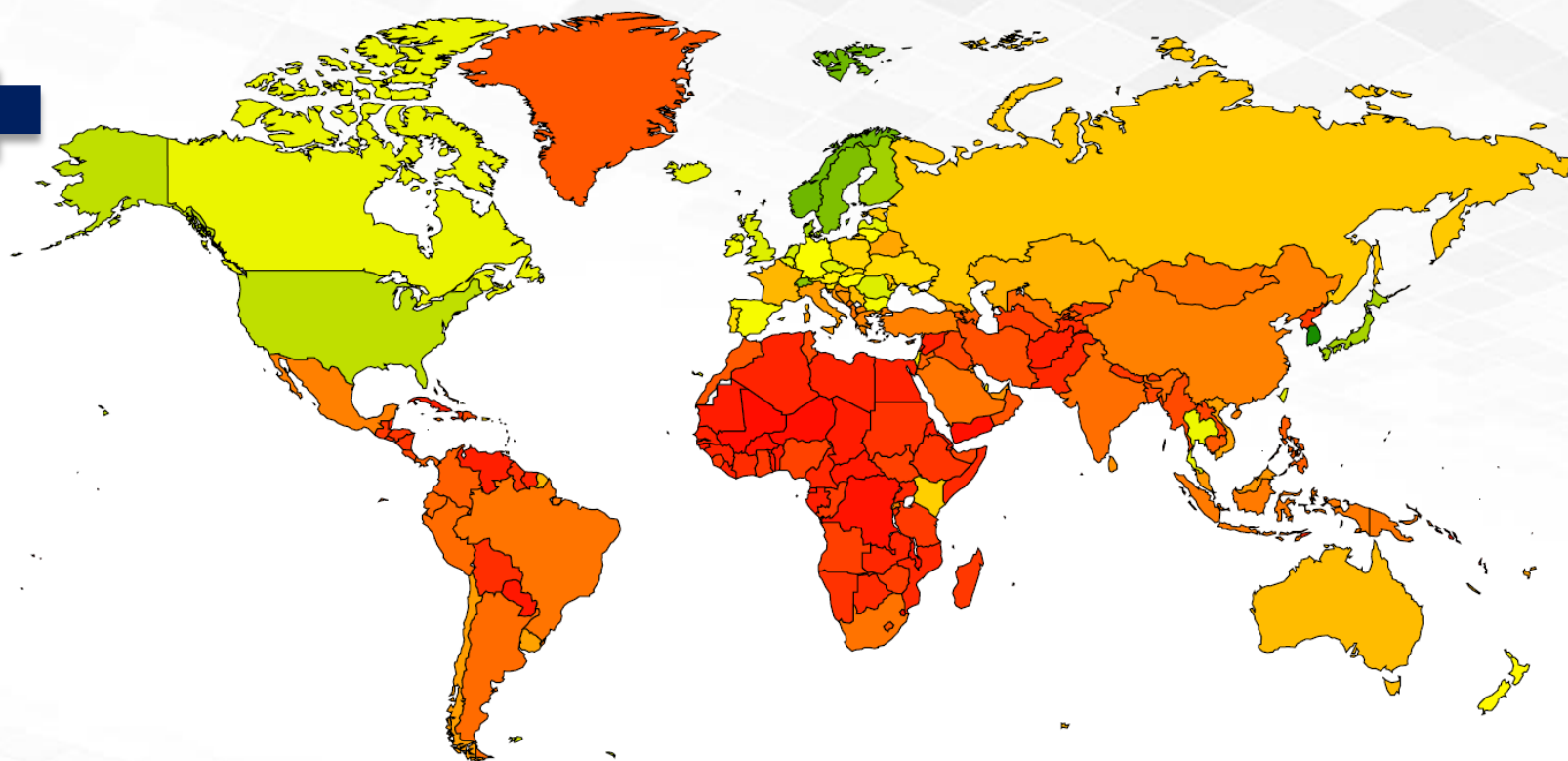

	Country/Region	Q1 2017 Avg. Mbps
-	Global	7.2
1	South Korea	28.6
2	Norway	23.5
3	Sweden	22.5
4	Hong Kong	21.9
5	Switzerland	21.7



Crescimento de Tráfego

Brasil tem mais de 5,7 mil provedores de Internet ativos, mas barreiras de crescimento persistem

terça-feira, 05 de junho de 2018 , 17h09

ISPs passam Oi e se tornam terceiro maior grupo de banda larga fixa em novembro

sexta-feira, 21 de dezembro de 2018 , 18h13

Fonte: TELETIME



Tecnologia DWDM

Padtec

Conectando Cidades

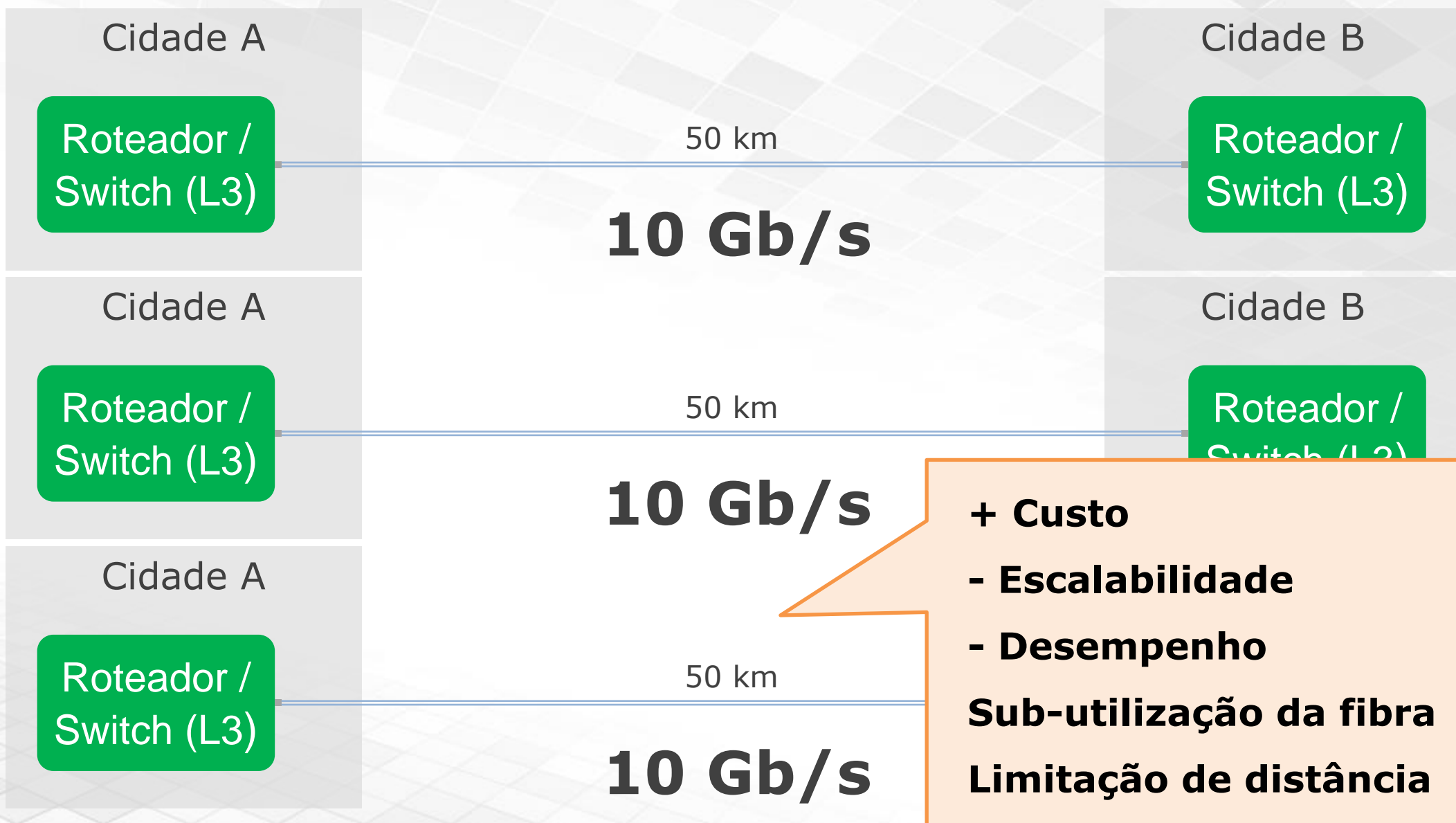

Colorindo Redes com a Tecnologia DWDM

Monocanal

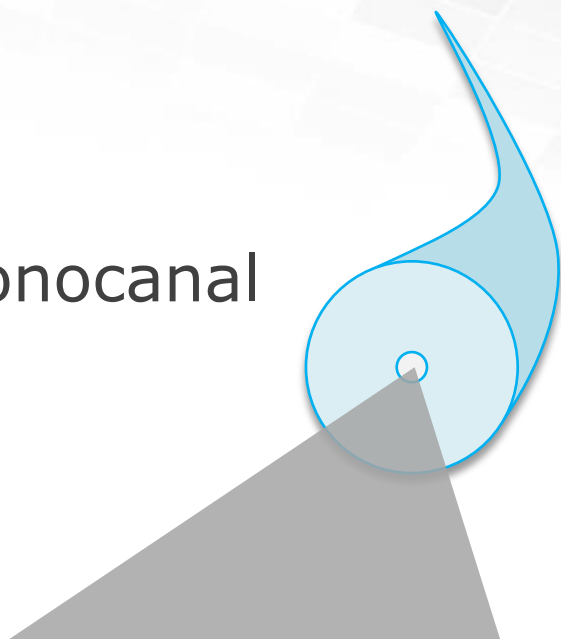

- *Plugável direto no roteador/switch*
- *Taxa de transmissão: 10G por fibra*
- *Enlace: ~80 km*
- *+ de 10G, usa-se outra fibra*

Dense Wavelength Division Multiplexing

DWDM



- *Sistema de transporte DWDM*
- *Taxa de transmissão: 4T+ por fibra*
- *Enlace: > 100 km*
- *Escalável: 10G inicial + N canais*

Grande capacidade de tráfego...

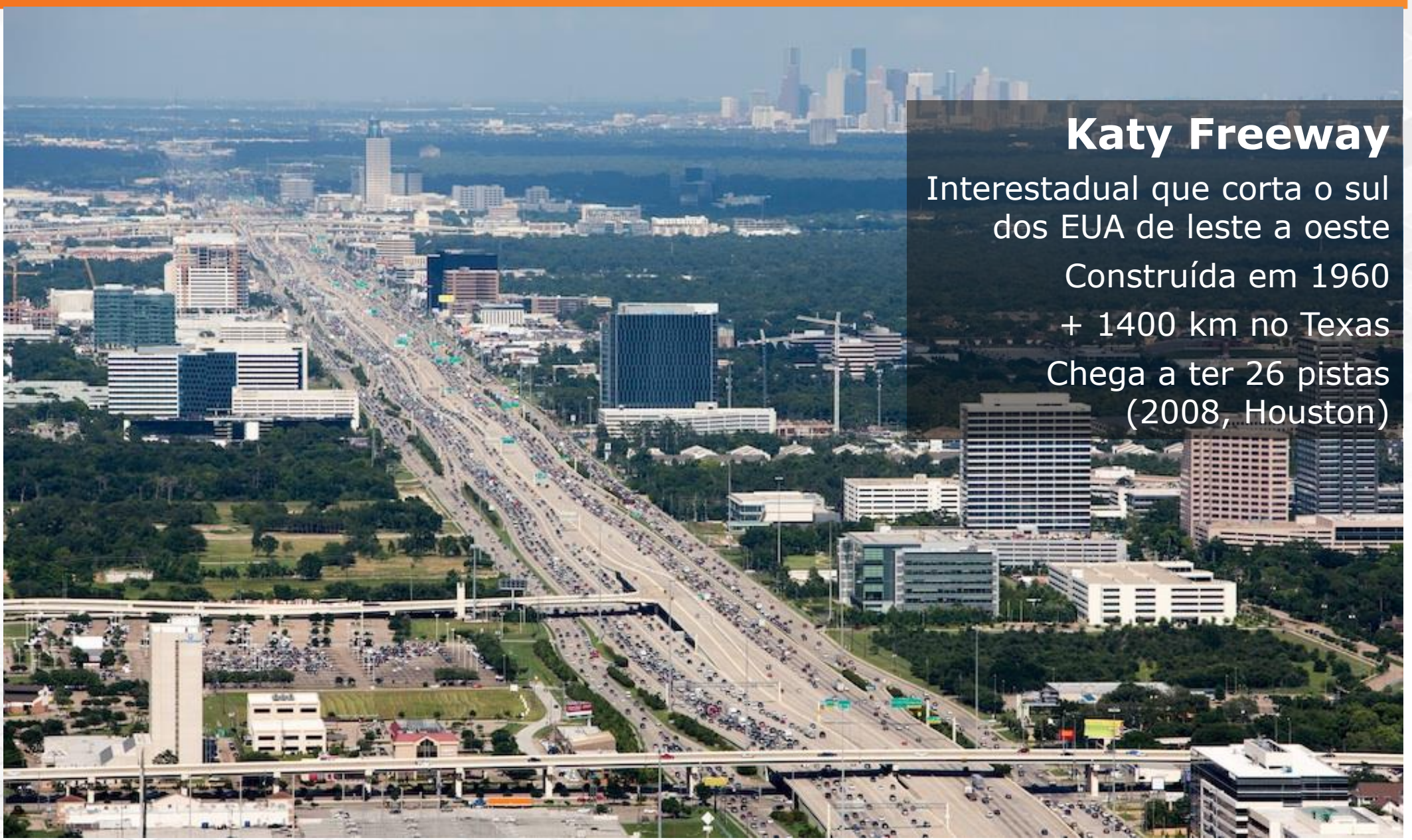

Katy Freeway

Interestadual que corta o sul dos EUA de leste a oeste

Construída em 1960

+ 1400 km no Texas

Chega a ter 26 pistas
(2008, Houston)

Evolução das Redes para DWDM

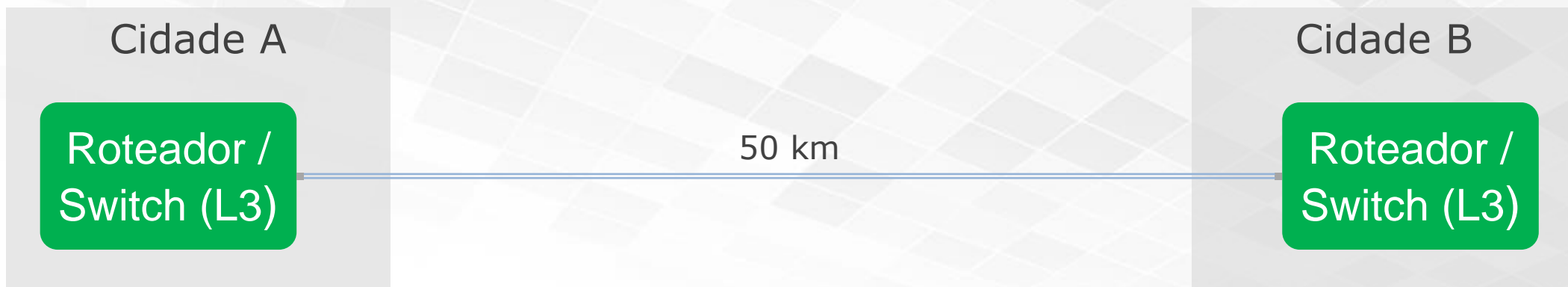

Colorindo...



Colorindo...

Sinal Cliente

Exemplo:
1310/1550 nm
Ethernet



Sinal Colorido

Canal DWDM (ITU-T),
Ex.: 1532,32 nm

OTN (OTU-2)

- Gerência
- FEC (7%)

Exemplo de Ocupação - 4U

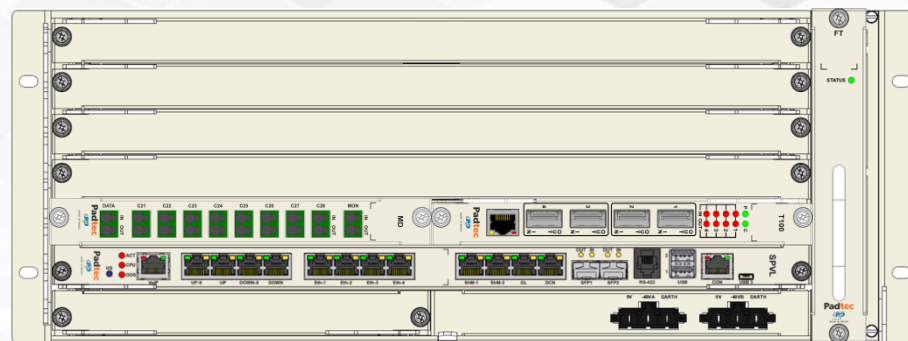

Multiplexando...



Exemplo de Ocupação - 4U

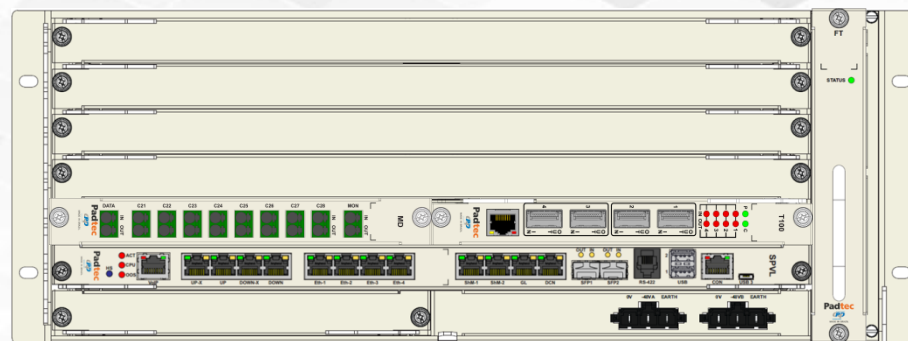

E se precisamos de distâncias maiores?

Amplificadores Ópticos

Tipos:

- EDFA
- Raman

Características:

- Sem conversão
- Ganho para N canais
- Ganho configurável



Exemplo de Ocupação - 4U

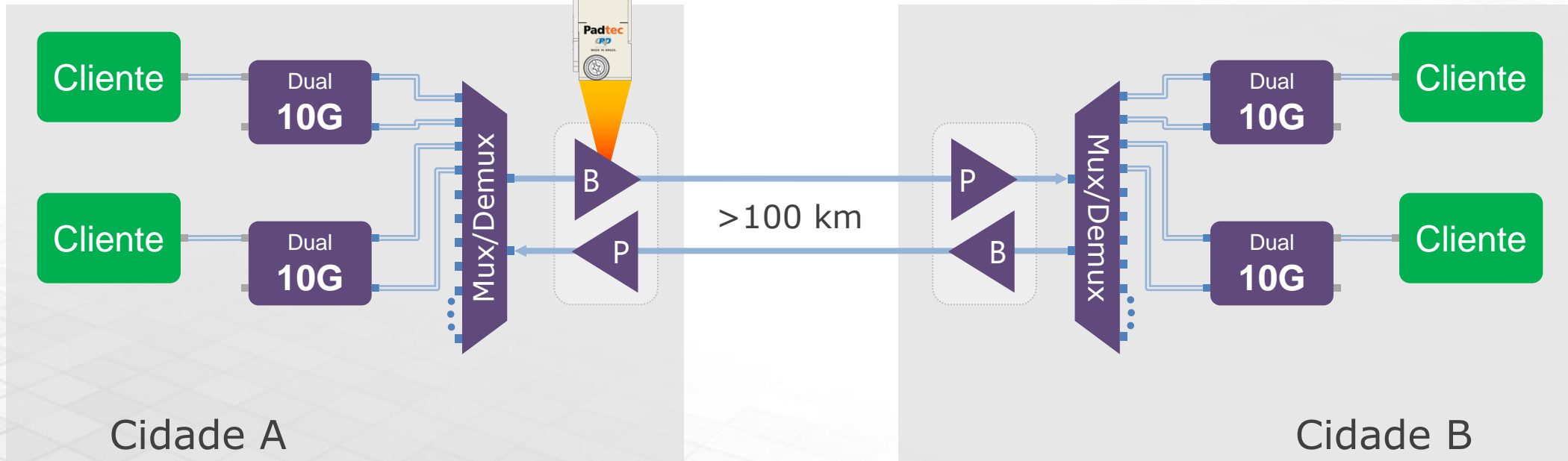
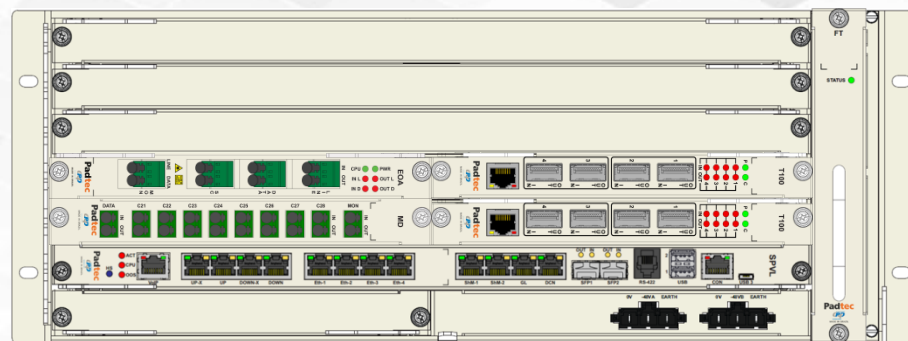

2019: DWDM, uma tecnologia mais acessível

Custo por gigabit

Transponders 2,5G - 10G - 40G - 100G - 200G

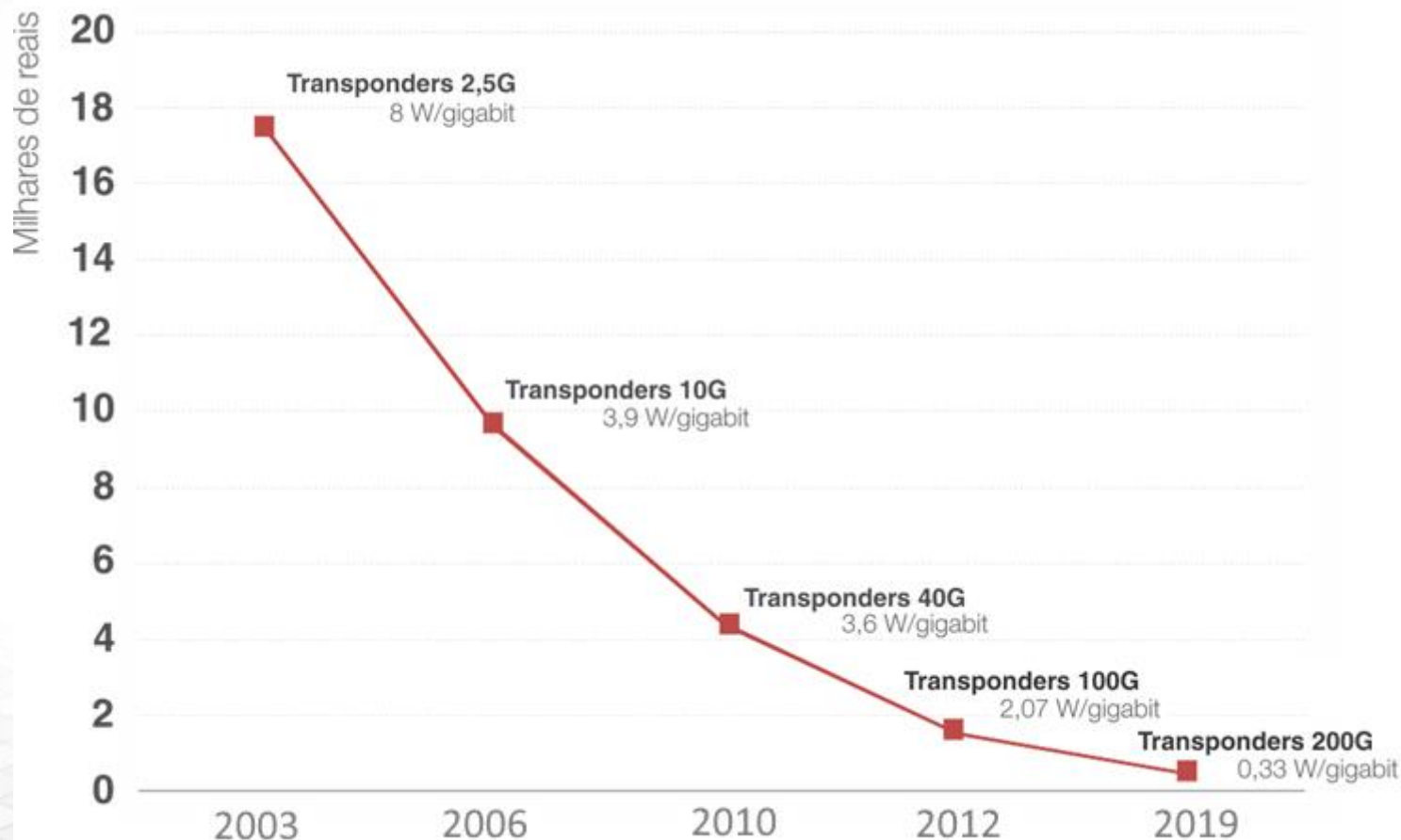

Nos últimos 16 anos, o custo por gigabit transmitido caiu, aproximadamente,

34x

E o consumo de energia por gigabit caiu

25x

Se um carro popular (cujo preço era de R\$ 15 mil em 2003) acompanhasse a mesma curva, hoje, esse mesmo carro, custaria **R\$ 750** e teria um consumo de **250 km/litro**.

*Para o estudo foram considerados valores de venda dos produtos logo após o lançamento.

*Sobre todos os valores foram aplicadas as correções de acordo com os índices de inflação oficiais.

Plataforma LightPad i6400G

Padtec

Portfólio de Equipamentos

Através da Plataforma **LightPad i6400G®**, a Padtec oferece uma solução **Carrier-class** para o **transporte multi-serviços** de alta capacidade em diversas arquiteturas de rede. A solução da Padtec é capaz de satisfazer as crescentes mudanças do perfil de tráfego, com alta flexibilidade e disponibilidade.

Com suporte a aplicações backbone terrestre e submarino, metro/agregação e SAN Extension, a Plataforma **LightPad i6400G** incorpora diversas tecnologias integradas para transporte de múltiplos serviços:

- DWDM - *Dense Wavelength Division Multiplexing*
- ROADM WSS - *Wavelength Selective Switch*
- OTN - *Optical Transport Network*
- OTN Switching
- ODU-XC - *Cross-connect*

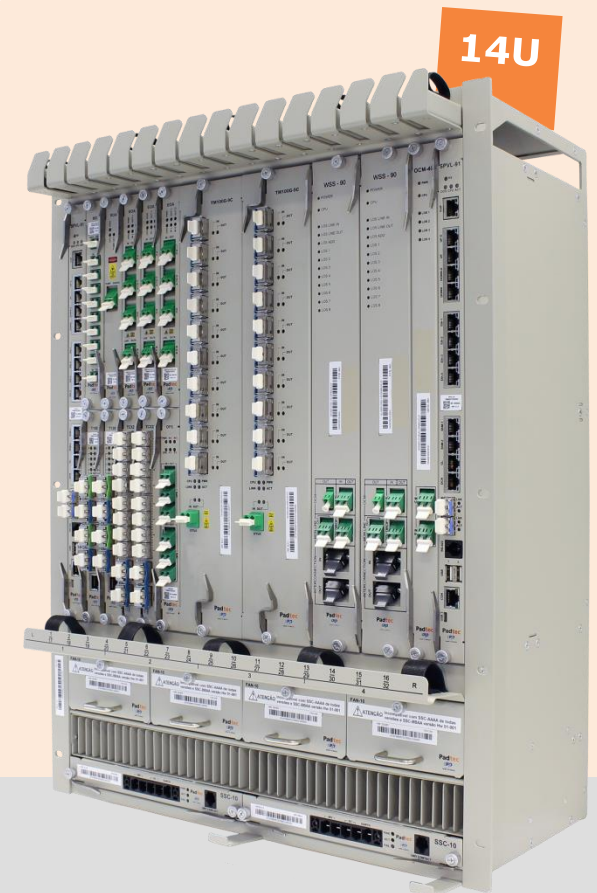
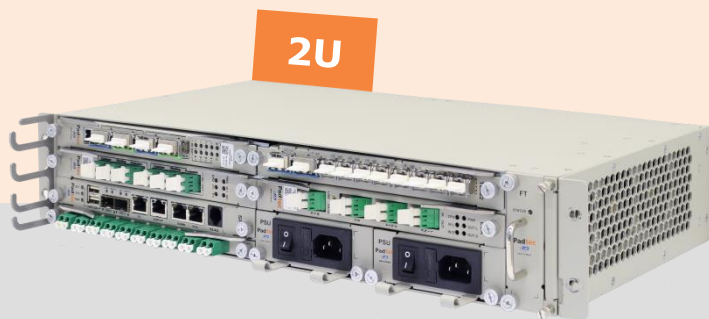

LightPad i6400G - Line Cards



Transponder 10G *Dual e Combinador*

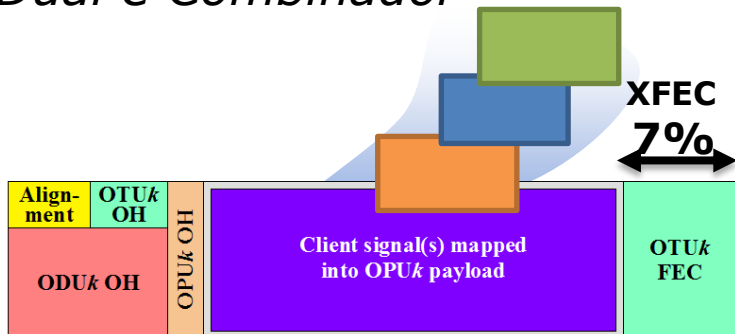

Transponder 100G/200G

- Combiner
- Muxponder
- Dual 100G
- Regenerador



Amplificadores *EDFA e Raman*

compatível com sub-racks de 14U e compacto 2U/4U

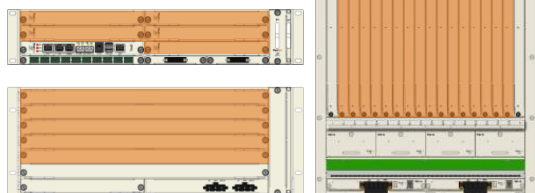

ROADM WSS



Chave Óptica *Proteção*

DWDM Passivos – Diferentes Capacidades

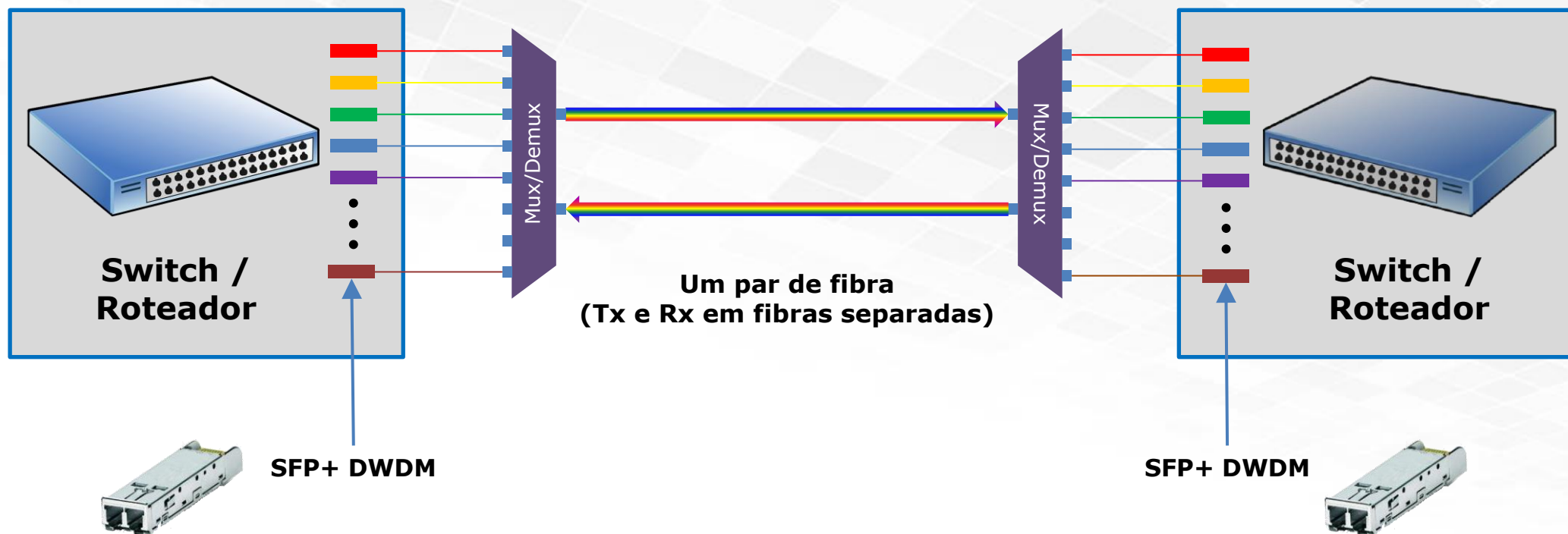

Parâmetros	8 canais	20 canais	40 canais
Atenuação Máx. suportada [dB]	15	13	9
Distância Máx. suportada em 0,25 dB/km e MS de 3 dB [km]*	48	40	24

Vantagem:

- Menor custo com equipamentos ativos;
- Fácil instalação e manutenção;
- Apenas um par de fibra óptica para transporte dos dados.

*O alcance máximo pode variar de acordo com a qualidade da fibra óptica e especificações técnicas dos plugáveis SFP+.

Exemplo: sistema ponto a ponto | 1 canal

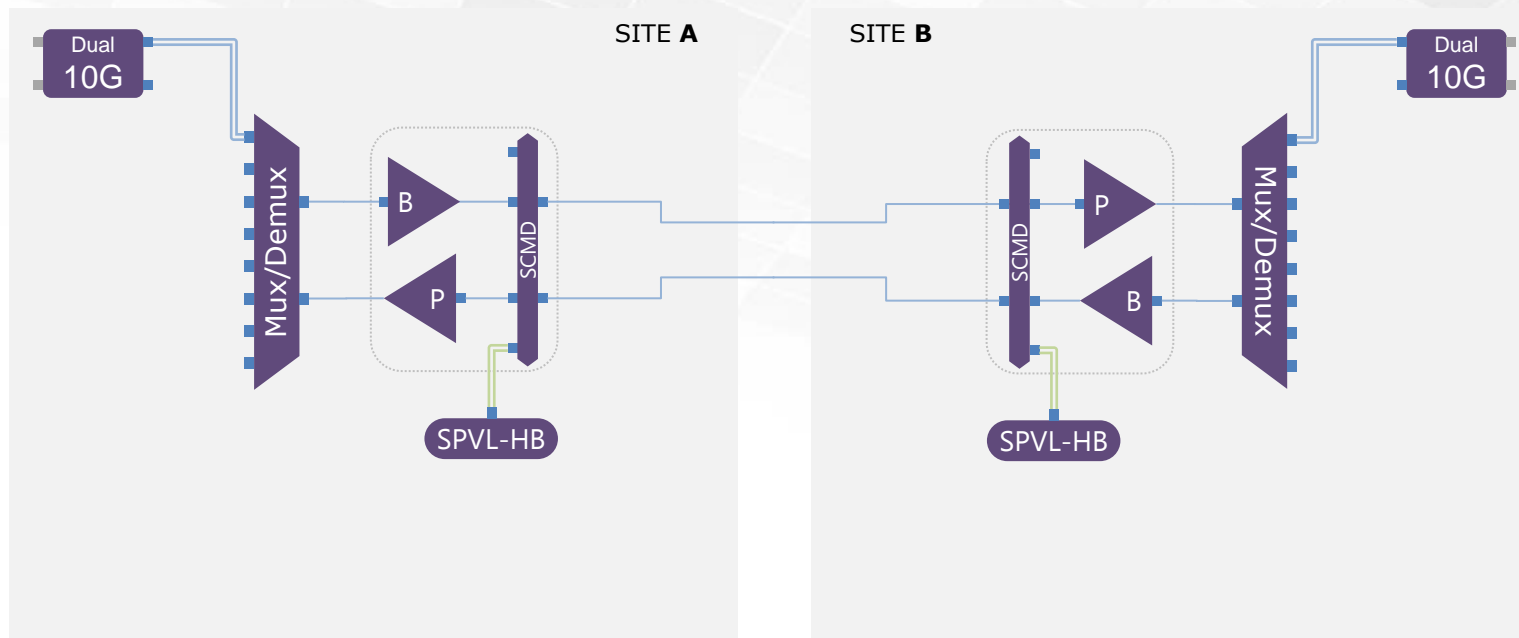

Características	
Alcance (redes Metro)	~80km
N de canais iniciais	1
N de canais total	8
Slots utilizados	2
Slots para expansão	3
Capacidade inicial	10 Gb/s
Capacidade total	80 Gb/s
Ocupação	2U

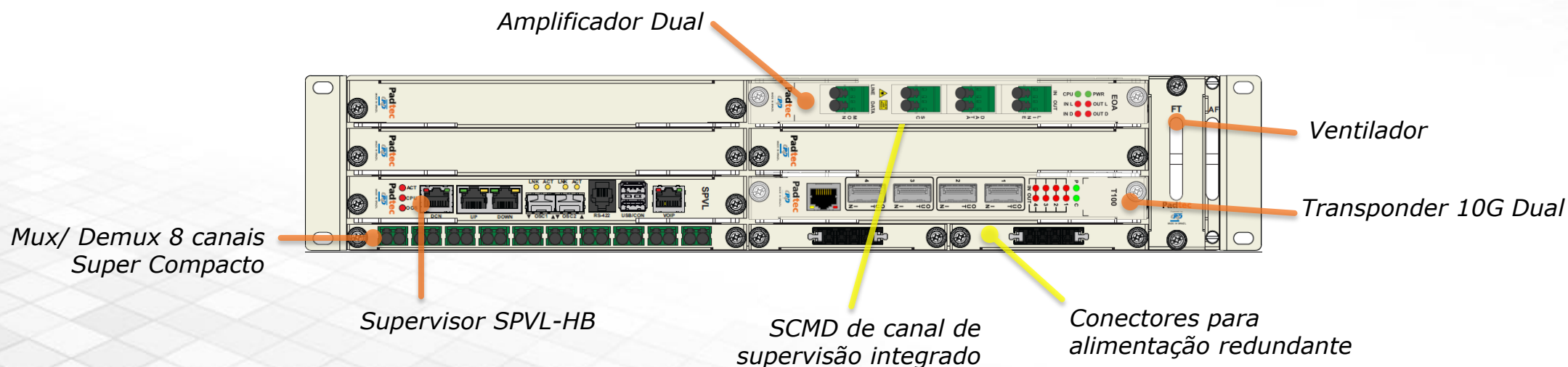

Exemplo: sistema ponto a ponto | 8 canais

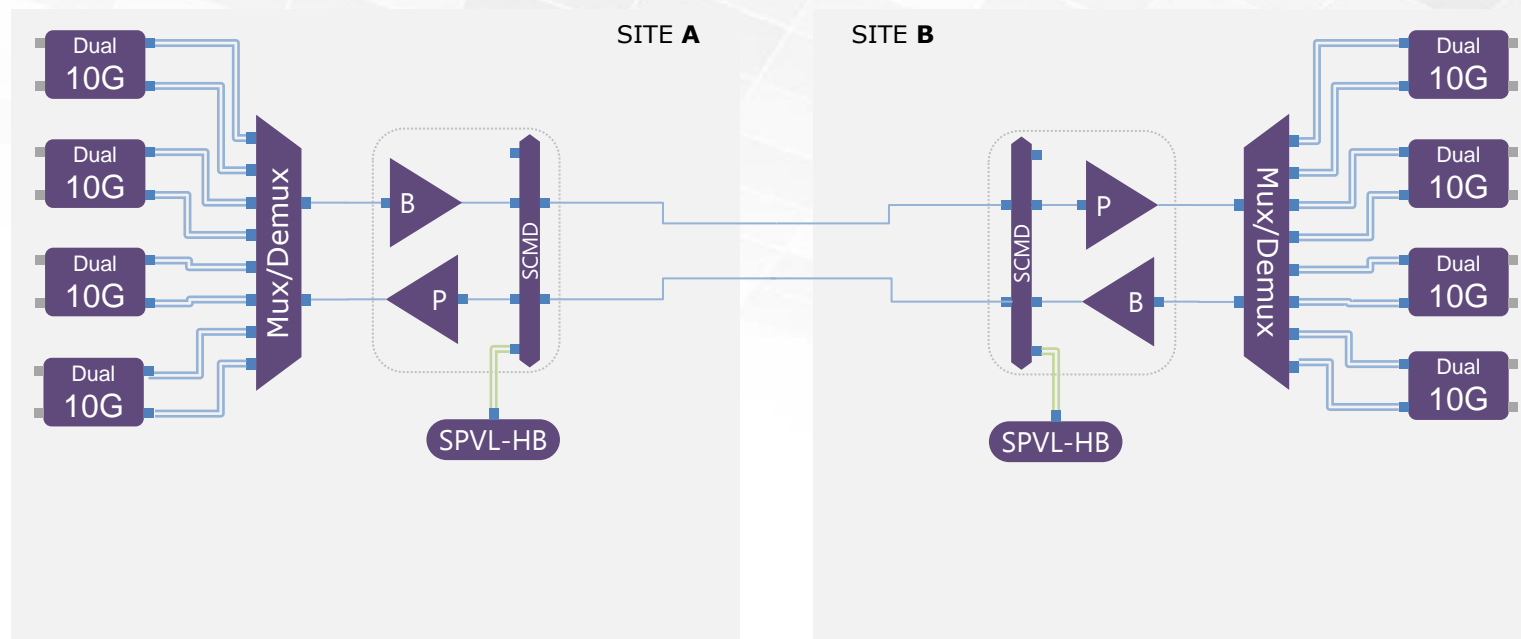

Características	
Alcance (redes Metro)	~80km
N de canais total	8
Capacidade total	80 Gb/s
Ocupação	2U

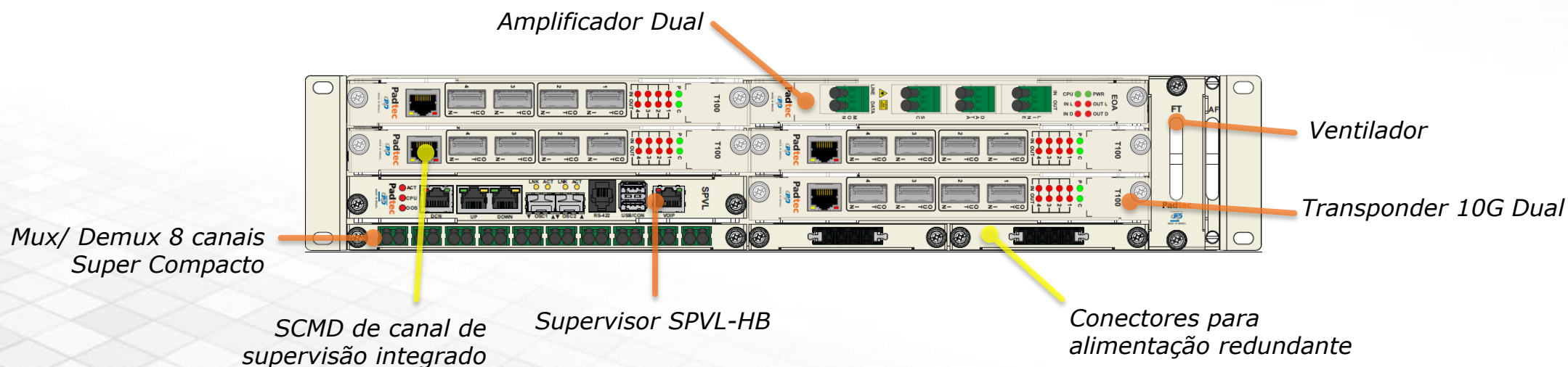

Sistemas ponto a ponto: Proteção de rota 8 canais

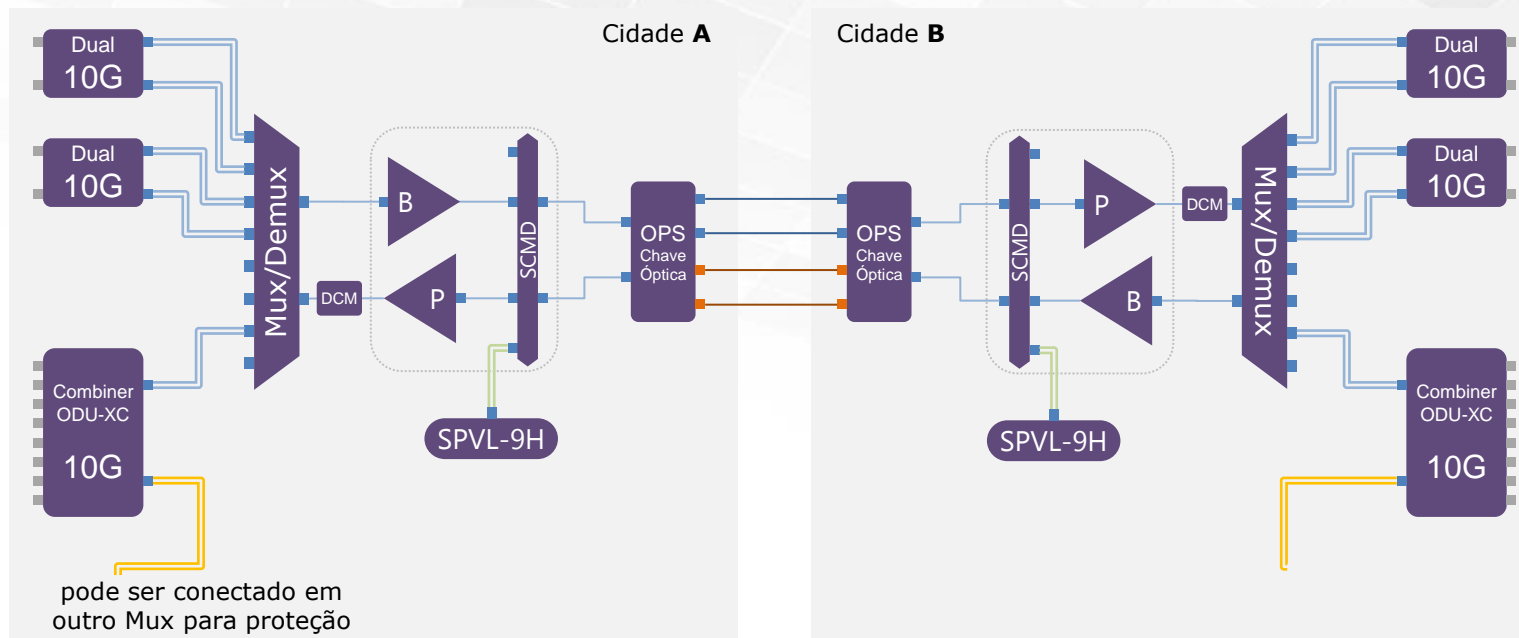

Características	
Alcance (redes Metro)	> 100 km
N de canais iniciais	5
N de canais total	8
Slots utilizados	8
Slots para expansão	2
Capacidade inicial	50 Gb/s
Capacidade total	80 Gb/s
Ocupação	4U
Proteção	de rota

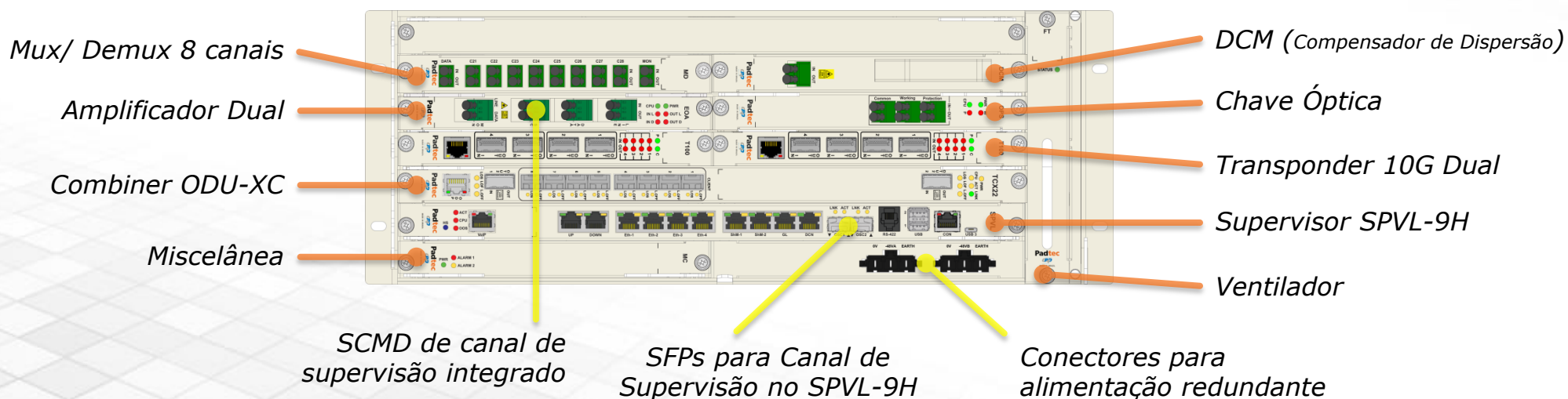

Um pouco sobre nós...

Padtec

Sobre nós...

- Início de operação em 2001
- Maior fabricante de sistemas de transmissão óptica na América Latina
- Portfólio completo de serviços profissionais para redes terrestres
- Fornecedor global: equipamentos e soluções vendidos em todos os continentes



Acionistas



O CPqD é responsável pelo mais extenso programa de pesquisa e desenvolvimento em TIC na América Latina, totalmente dedicado a prover soluções para telecomunicações, finanças, energia, entre outras indústrias, tanto no setor privado como público.



A Ideiasnet é uma companhia com ações negociadas na Bovespa, que investe em empresas do setor de Tecnologia, Mídia e Telecomunicações. Atua ativamente em suas investidas na definição de estratégias, no posicionamento de mercado e na estruturação de fusões e aquisições.



BNDESPAR é responsável pela operação de renda variável, realiza investimentos em empresas dos setores prioritários na estratégia do BNDES, como energia renovável, fornecimento de óleo e gás, tecnologia da informação e comunicações, biotecnologia, etanol (segunda geração) e *green technology*.

Padtec S/A - Clientes

Provedores							Integradoras
							
Operadoras							
							
							
Governo							
							

Redes Iluminadas

*Mais de 200 mil km
de redes implantadas*

— *Backbones DWDM*

● *Redes Metro em
importantes cidades
latino-americanas*

Portfólio de Serviços



NOC – Campinas/SP

Gerenciamento de Redes:

- Operação 24x7
- Monitoramento e acionamentos em equipamentos e infraestrutura
- Suporte a ativações
- Relatórios de desempenho
- Mitigação de riscos

Atuação global com qualidade diferenciada a partir de uma equipe de engenharia de O&M com profissionais altamente qualificados e equipamentos de última geração.

Caracterização de Redes:

- Medidas completas
- Localização de trechos críticos
- Ações de recuperação

Implantação de Sistemas:

- Site survey e projeto de instalação
- Instalação e comissionamento
- Documentação

Suporte On-Site:

- Equipes e frotas próprias
- Instrumental de última geração
- Vistorias
- Gestão de sobressalentes

Uma reflexão...

Padtec

Fibras/Rodovias, uma diferença importante...

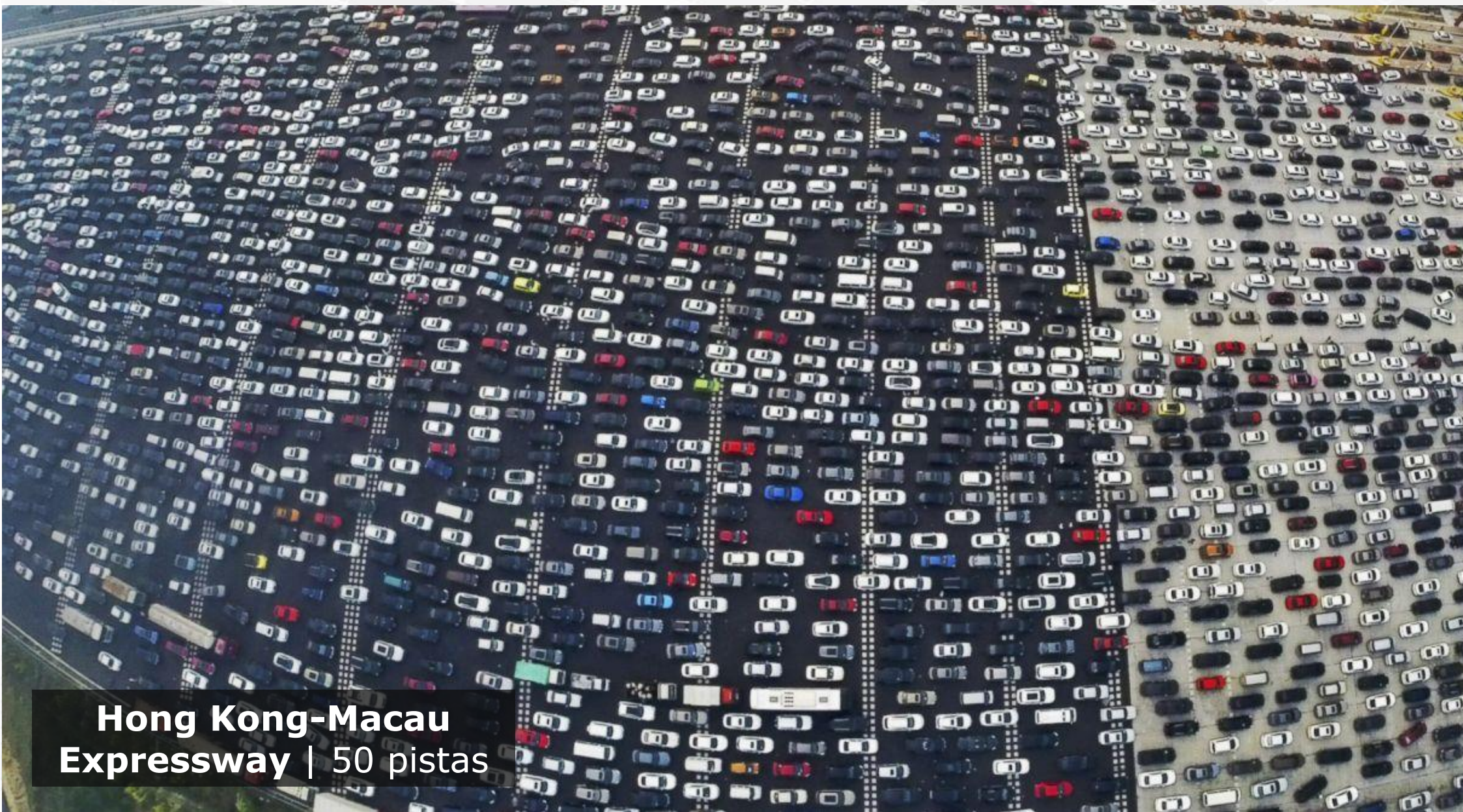

**Hong Kong-Macau
Expressway | 50 pistas**

Padtec



padtec.com