

O uso da tecnologia DWDM em redes de provedores de internet

Fabrício Marchiori
Marketing de Produto
mktproduto@padtec.com.br

Padtec

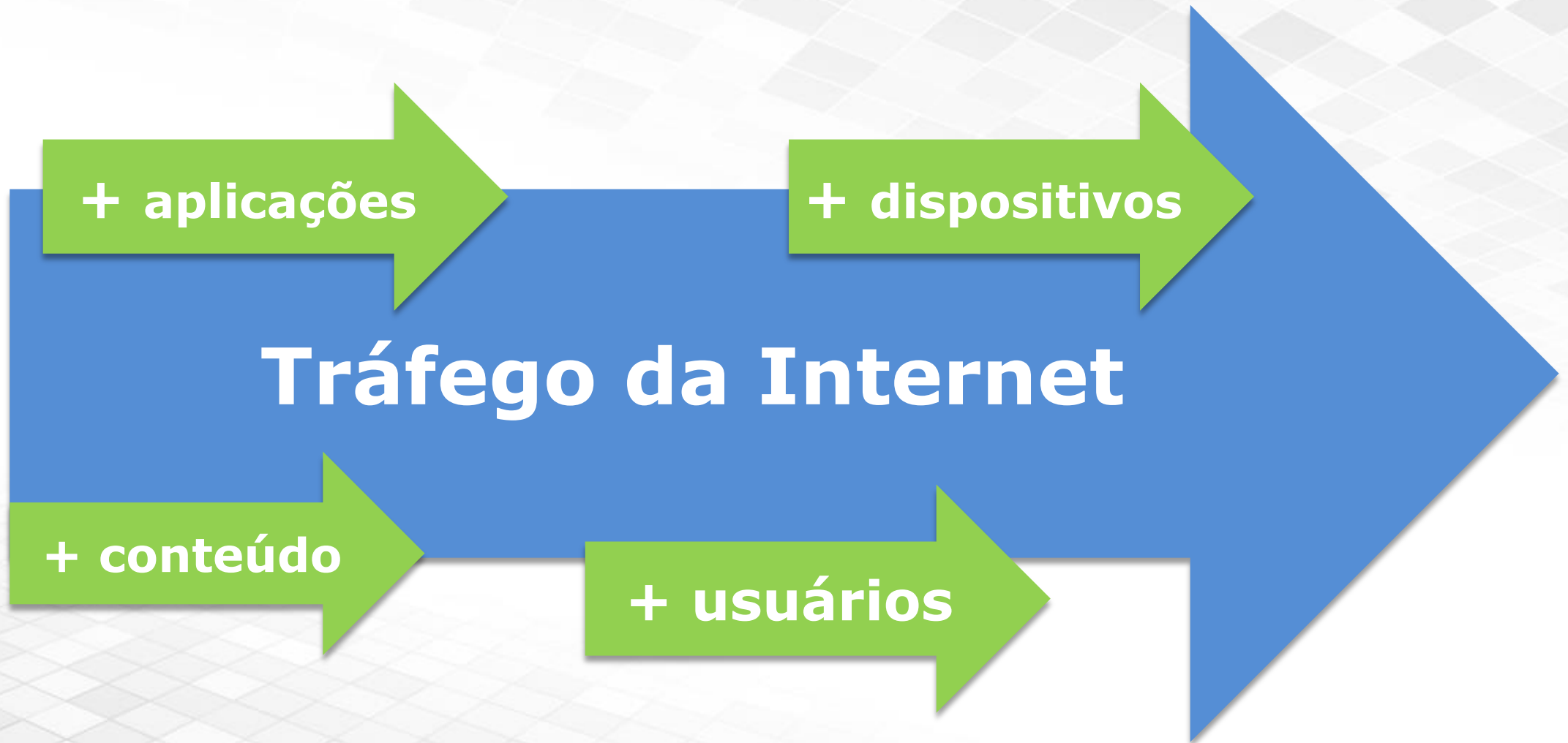

Queremos sempre mais...

Cenário:

- *IoT*
- *M2M*
- *Big Data*
- *Vídeo (HD, 4k...)*
- *Dispositivos Móveis*
- *Gaming*

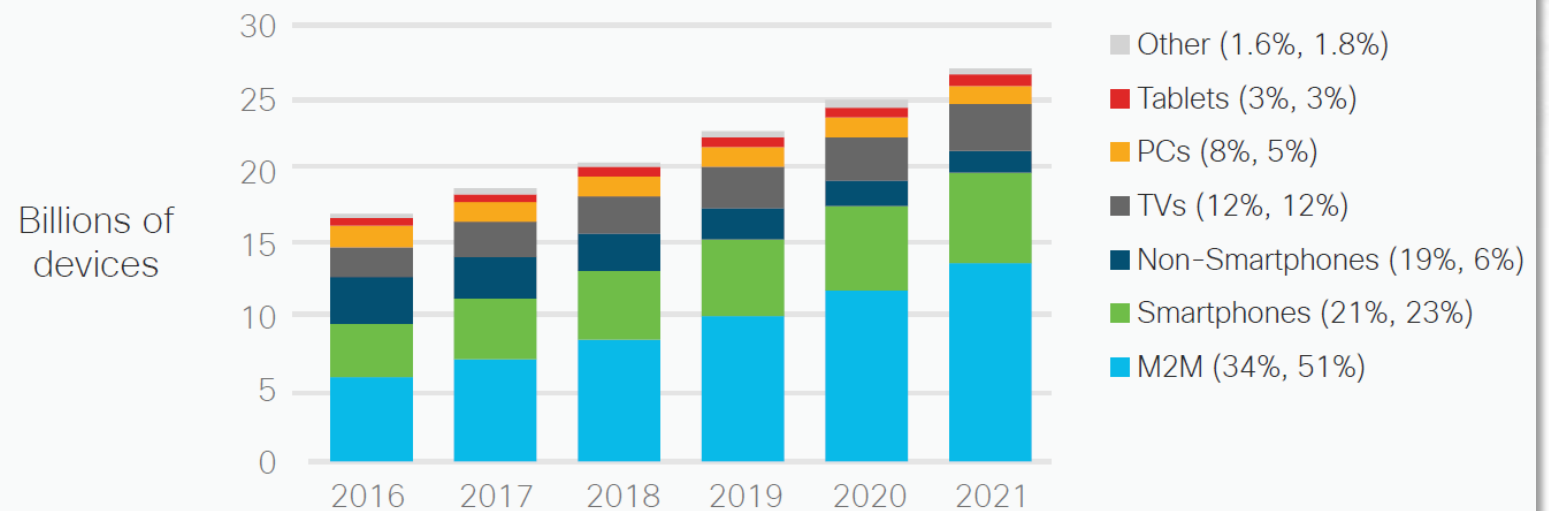
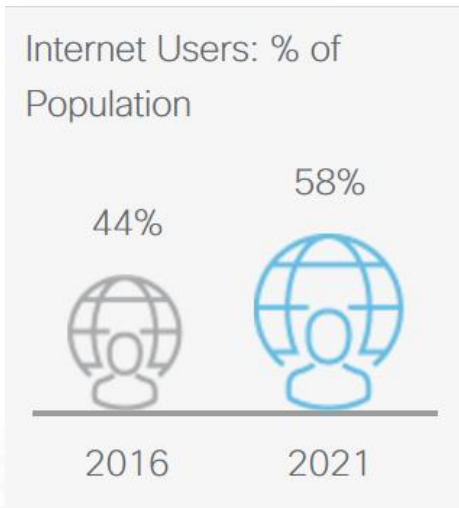
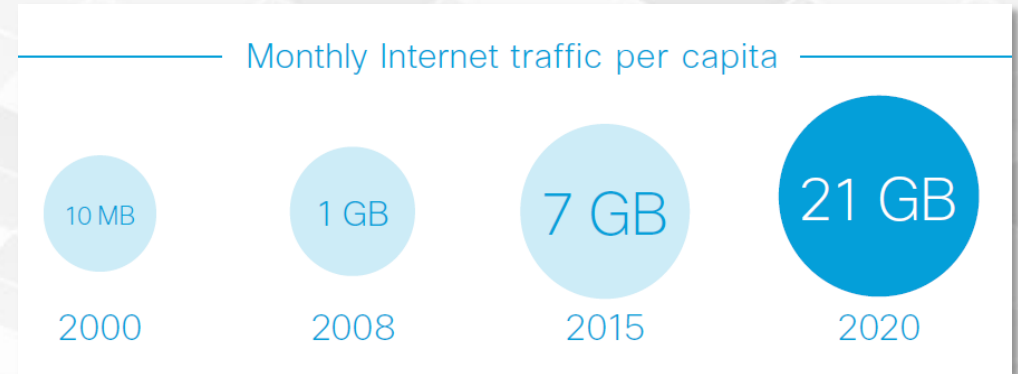

Figures (n) refer to 2016, 2021 device share.
Source: Cisco VNI Global IP Traffic Forecast, 2016-2021.

Média da Velocidade de Conexão

Fonte: Akamai | State of The Internet
Q1 2017 Report

Global Rank	Country/Region	Q1 2017 Avg. Mbps
10	United States	18.7
20	Canada	16.2
57	Uruguay	9.5
60	Chile	9.3
76	Mexico	7.5
79	Brazil	6.8
90	Argentina	6.3
91	Peru	6.2
92	Ecuador	6.2
94	Panama	5.9
99	Colombia	5.5
112	Costa Rica	4.1
132	Bolivia	2.7
144	Venezuela	1.8
148	Paraguay	1.4

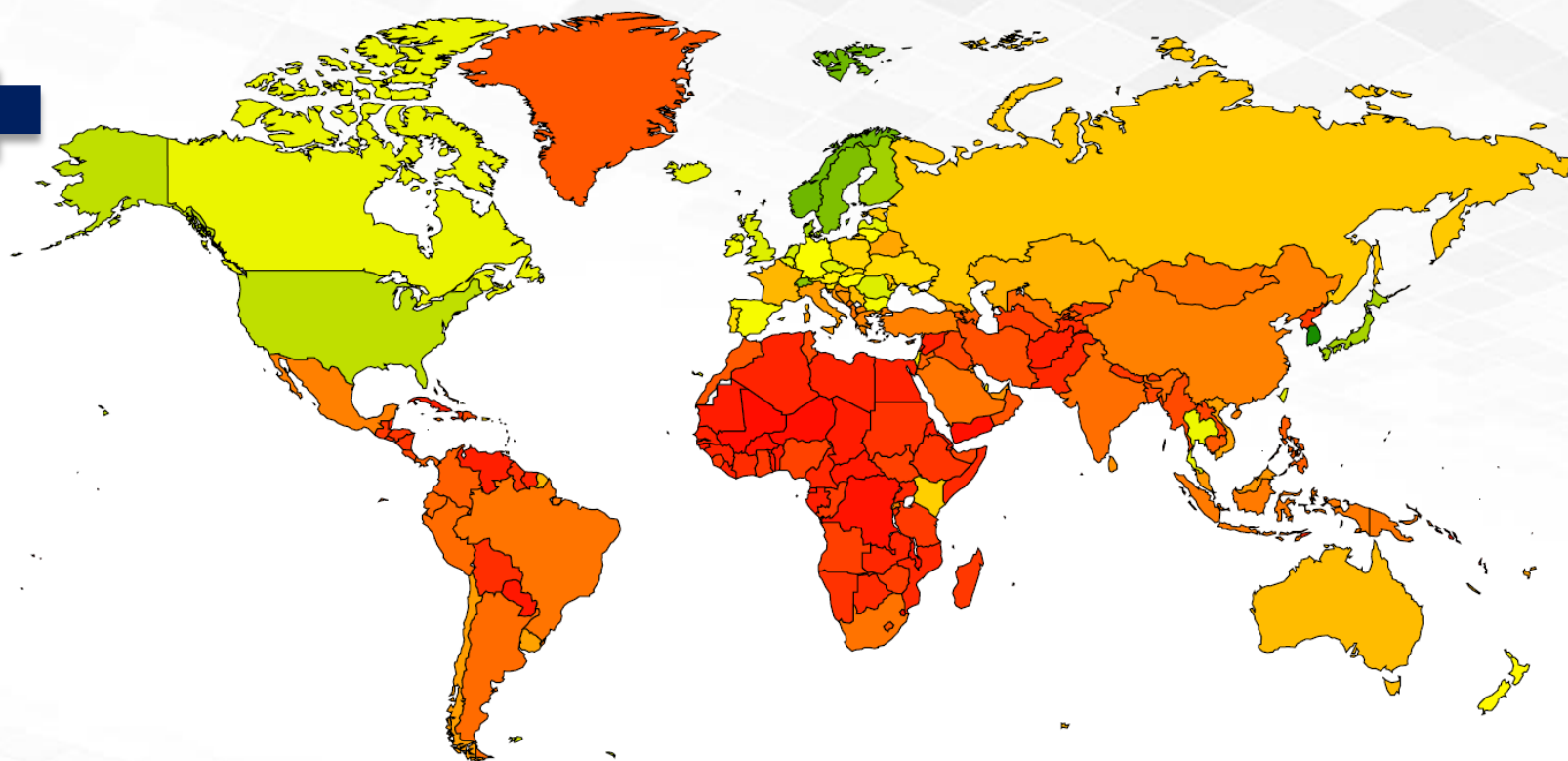

	Country/Region	Q1 2017 Avg. Mbps
-	Global	7.2
1	South Korea	28.6
2	Norway	23.5
3	Sweden	22.5
4	Hong Kong	21.9
5	Switzerland	21.7



Crescimento de Tráfego



Qtd Provedores

2.138

Foram identificadas **2.138** empresas atuando nesse mercado no Brasil em 2014. Dos 2.138 provedores de serviços de Internet, 68% estão sediados nas regiões Sul e Sudeste. Já a região Norte é sede para apenas 5% das empresas de provimento de serviço de Internet.

TIC Provedores
2014 - CGI

Operadoras
segurando
investimentos

+ aplicações

+ dispositivos

Acessibilidade
de tecnologias

Tráfego da Internet (ISP)

+ conteúdo

Oportunidades
de parceria e
swap de redes

+ usuários

Carência
de Infra

2018: DWDM, uma tecnologia mais acessível

Até ~ 2003

- 02/03 – Explosão ônibus espacial Columbia
- 07/03 – É lançado o Skype
- 08/03 – Surge o MySpace

Transponders de 2,5G tinham uma boa saída e eram a alternativa de baixo custo de entrada para canais DWDM:

Transponders 2,5 Gb/s



2018

- Transponders **100G** já são vendidos para provedores e os modelos de **200G** estão sendo lançados para 2018

100 Gb/s



Interface
10 Gb/s (4x mais)



Custo por bit
aproximadamente
36x menor

Tecnologia DWDM

Padtec

Conectando Cidades

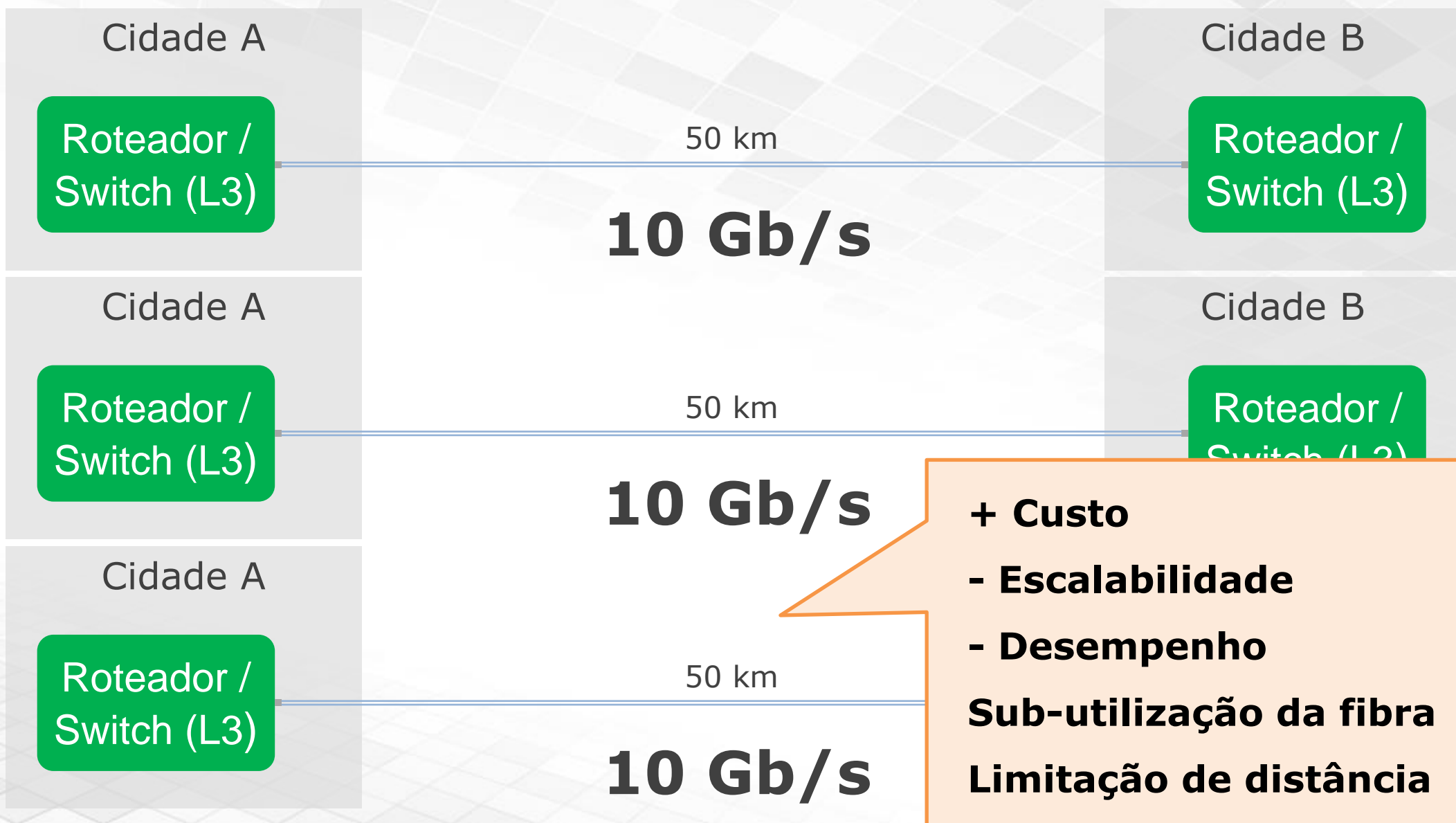

Colorindo Redes com a Tecnologia DWDM

Monocanal

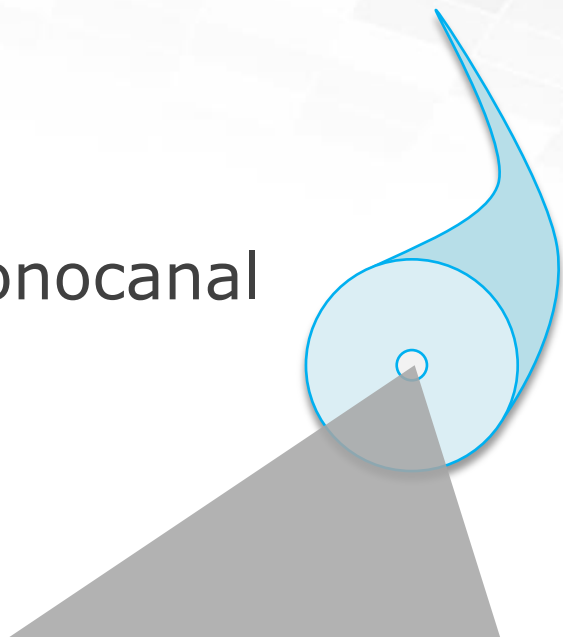

- *Plugável direto no roteador/switch*
- *Taxa de transmissão: 10G por fibra*
- *Enlace: ~80 km*
- *+ de 10G, usa-se outra fibra*

Dense Wavelength Division Multiplexing

DWDM



- *Sistema de transporte DWDM*
- *Taxa de transmissão: 4T+ por fibra*
- *Enlace: > 100 km*
- *Escalável: 10G inicial + N canais*

Grande capacidade de tráfego...

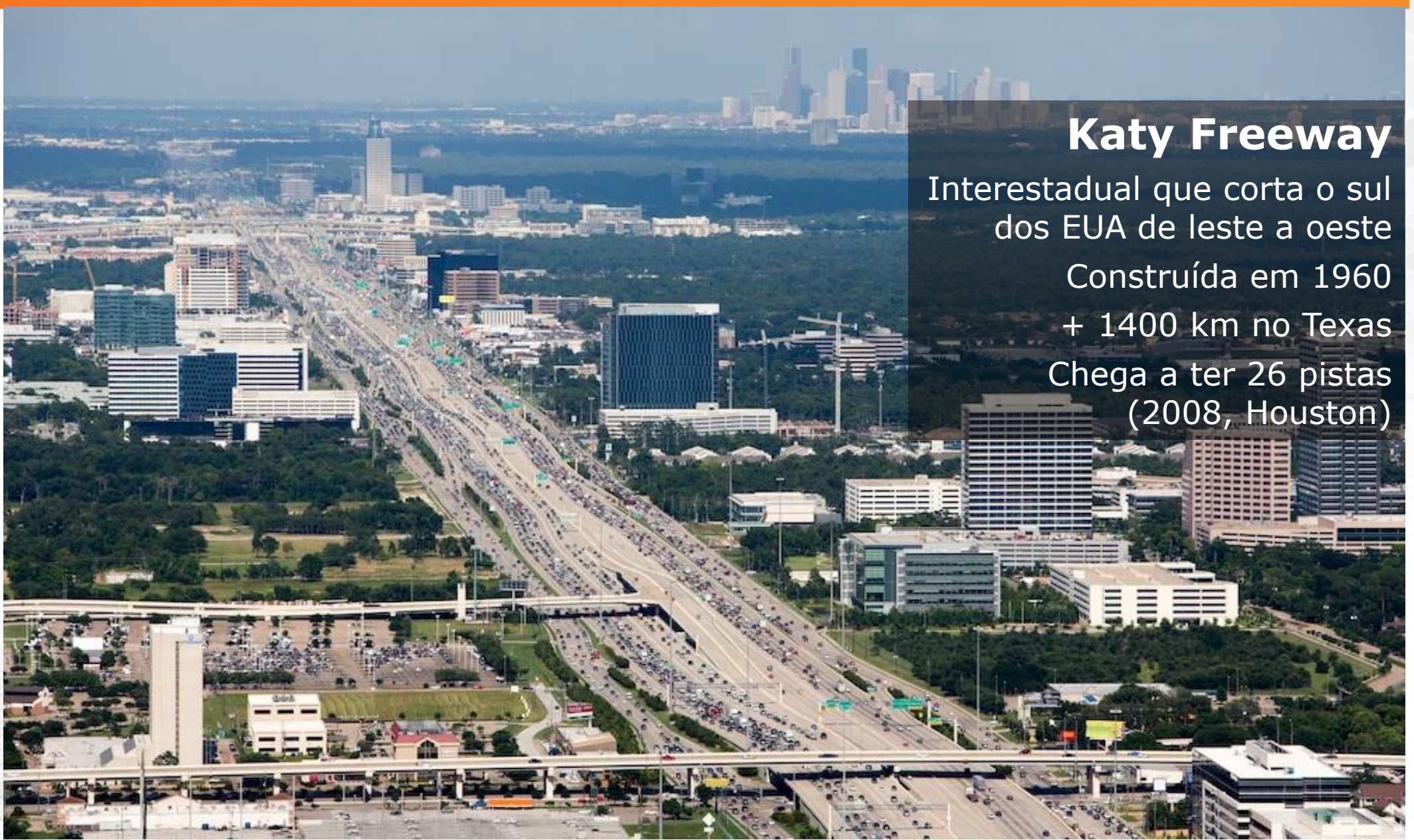

Katy Freeway

Interestadual que corta o sul dos EUA de leste a oeste

Construída em 1960

+ 1400 km no Texas

Chega a ter 26 pistas
(2008, Houston)

Evolução das Redes para DWDM

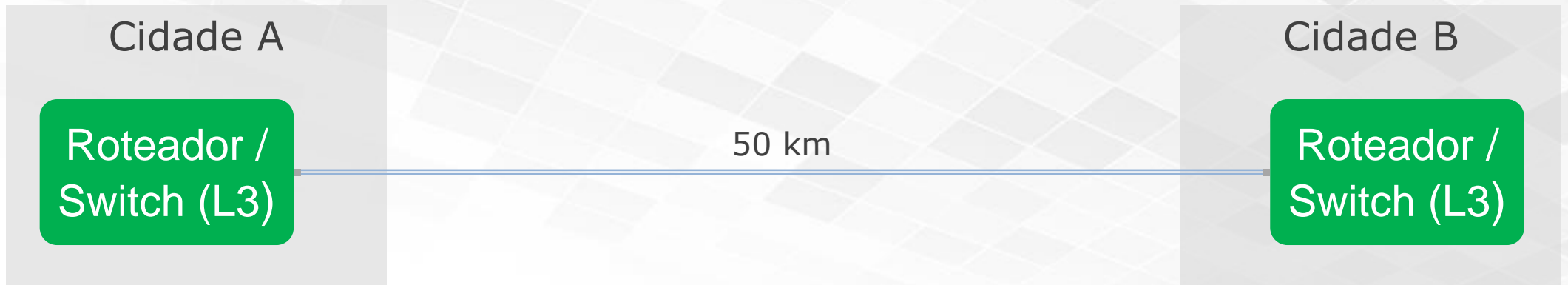

Colorindo...



Colorindo...

Sinal Cliente

Exemplo:
1310/1550 nm
Ethernet



Sinal Colorido

Canal DWDM (ITU-T),
Ex.: 1532,32 nm

OTN (OTU-2)

- Gerência
- FEC (7%)

Exemplo de Ocupação - 4U

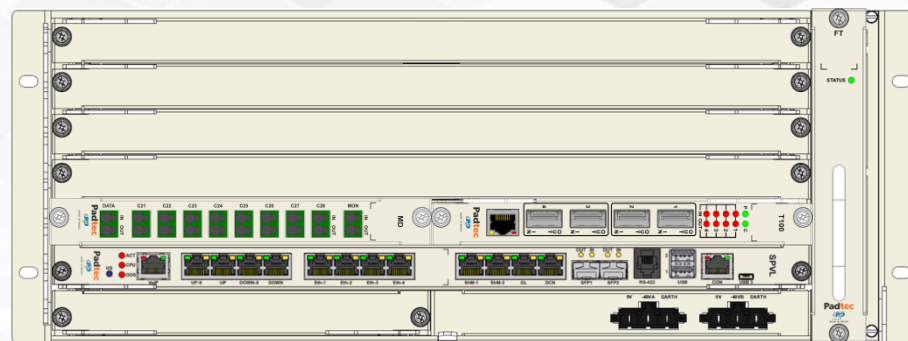

Multiplexando...



Exemplo de Ocupação - 4U

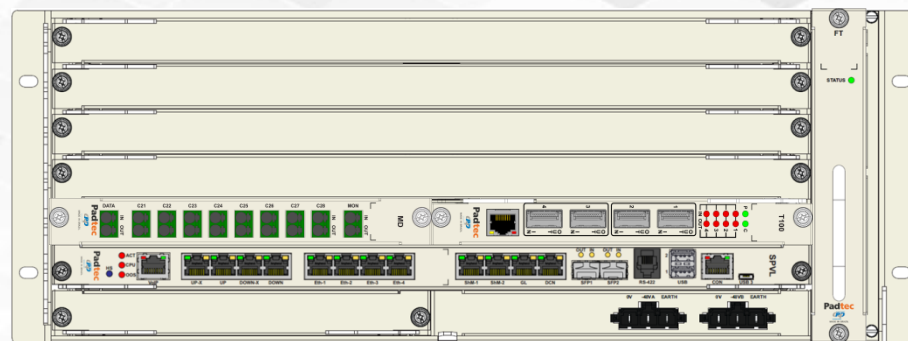

E se precisamos de distâncias maiores?

Amplificadores Ópticos

Tipos:

- EDFA
- Raman

Características:

- Sem conversão
- Ganho para N canais
- Ganho configurável



Exemplo de Ocupação - 4U

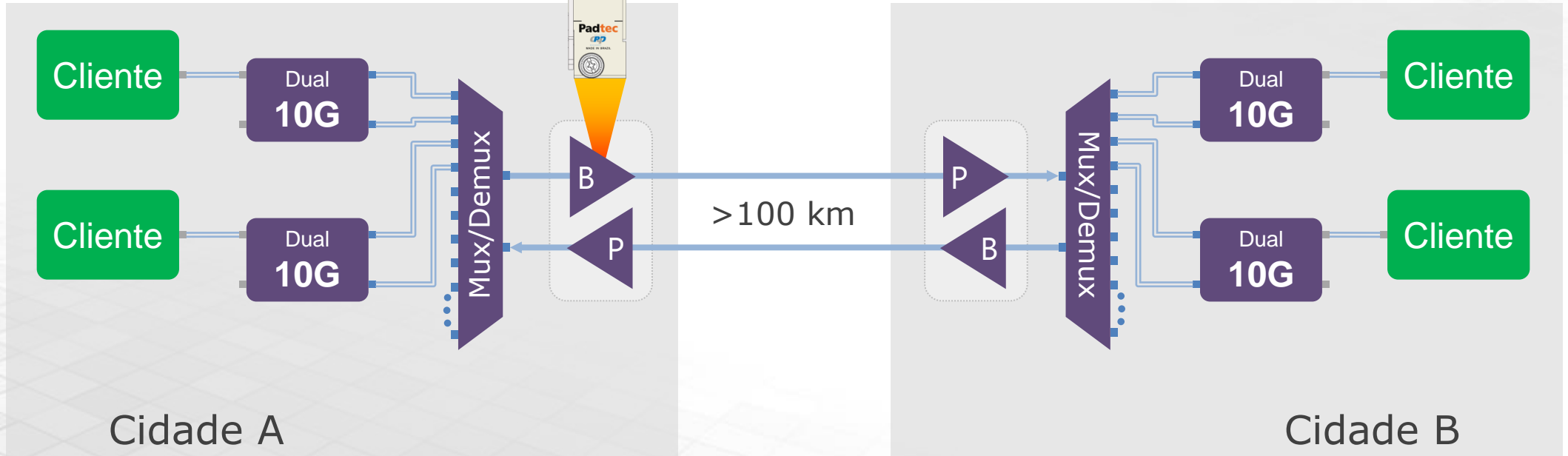
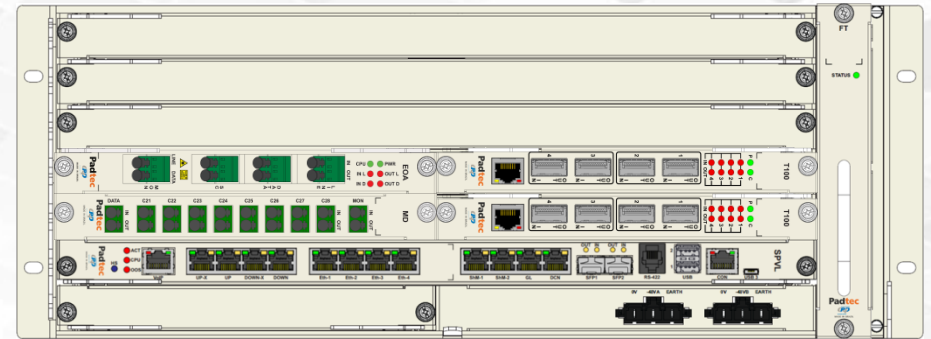

Plataforma LightPad i6400G

Padtec

Portfólio de Equipamentos

Através da Plataforma **LightPad i6400G®**, a Padtec oferece uma solução **Carrier-class** para o **transporte multi-serviços** de alta capacidade em diversas arquiteturas de rede. A solução da Padtec é capaz de satisfazer as crescentes mudanças do perfil de tráfego, com alta flexibilidade e disponibilidade.

Com suporte a aplicações backbone terrestre e submarino, metro/agregação e SAN Extension, a Plataforma **LightPad i6400G** incorpora diversas tecnologias integradas para transporte de múltiplos serviços:

- DWDM - *Dense Wavelength Division Multiplexing*
- ROADM WSS - *Wavelength Selective Switch*
- OTN - *Optical Transport Network*
- OTN Switching
- ODU-XC - *Cross-connect*

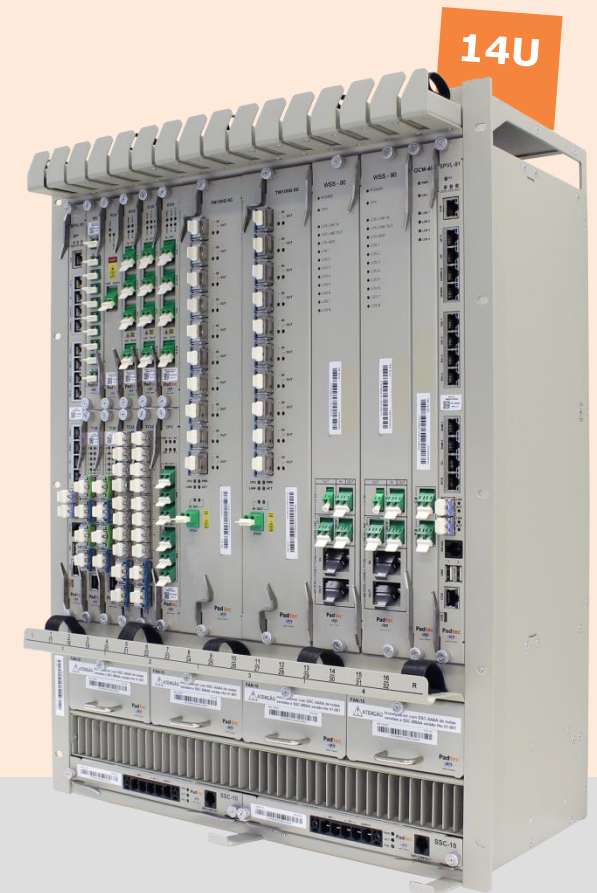
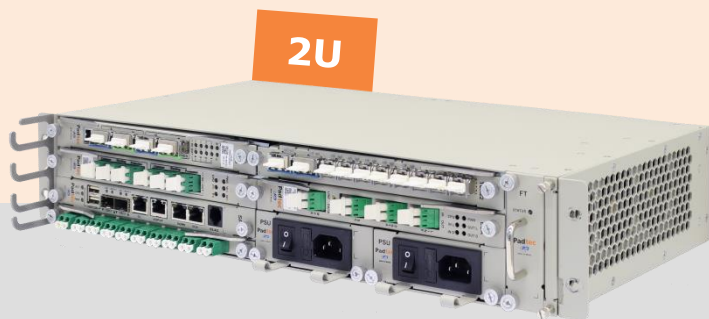

LightPad i6400G - Line Cards



Transponder 10G *Dual e Combinador*

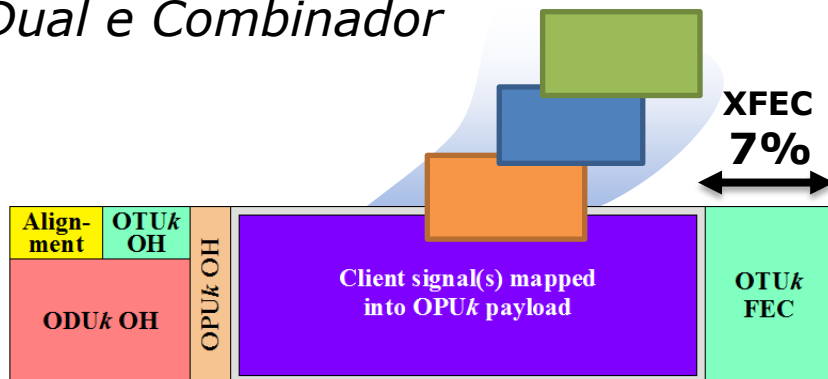

Transponder 100G

- Flexponder
- Muxponder
- Terminal
- Regenerador



Amplificadores *EDFA e Raman*



ROADM WSS



Chave Óptica *Proteção*

compatível com sub-racks de 14U e compacto 2U/4U



Exemplo: sistema ponto a ponto | 1 canal

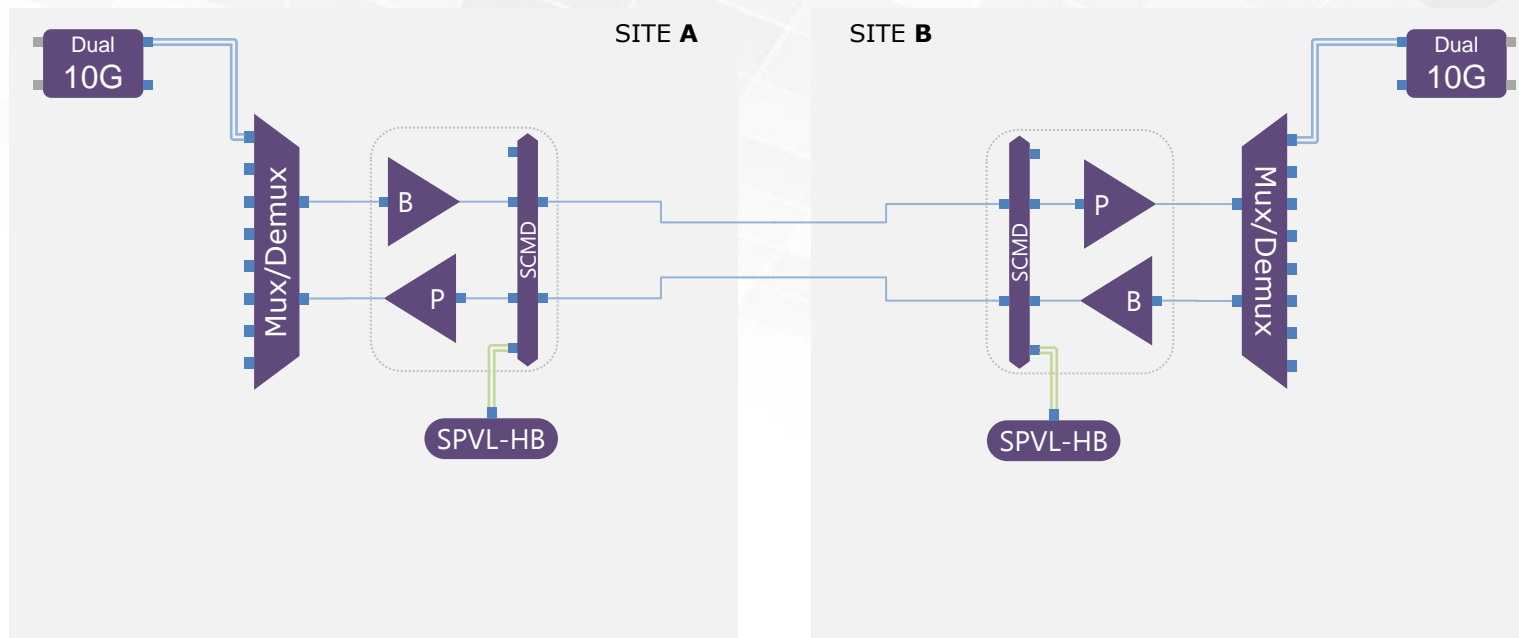

Características	
Alcance (redes Metro)	~80km
N de canais iniciais	1
N de canais total	8
Slots utilizados	2
Slots para expansão	3
Capacidade inicial	10 Gb/s
Capacidade total	80 Gb/s
Ocupação	2U

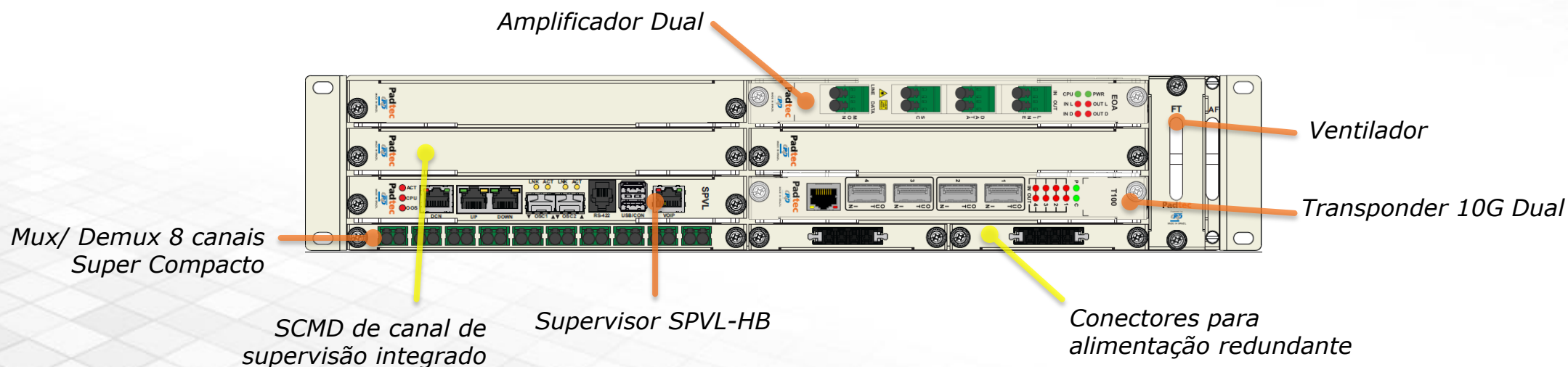

Exemplo: sistema ponto a ponto | 8 canal

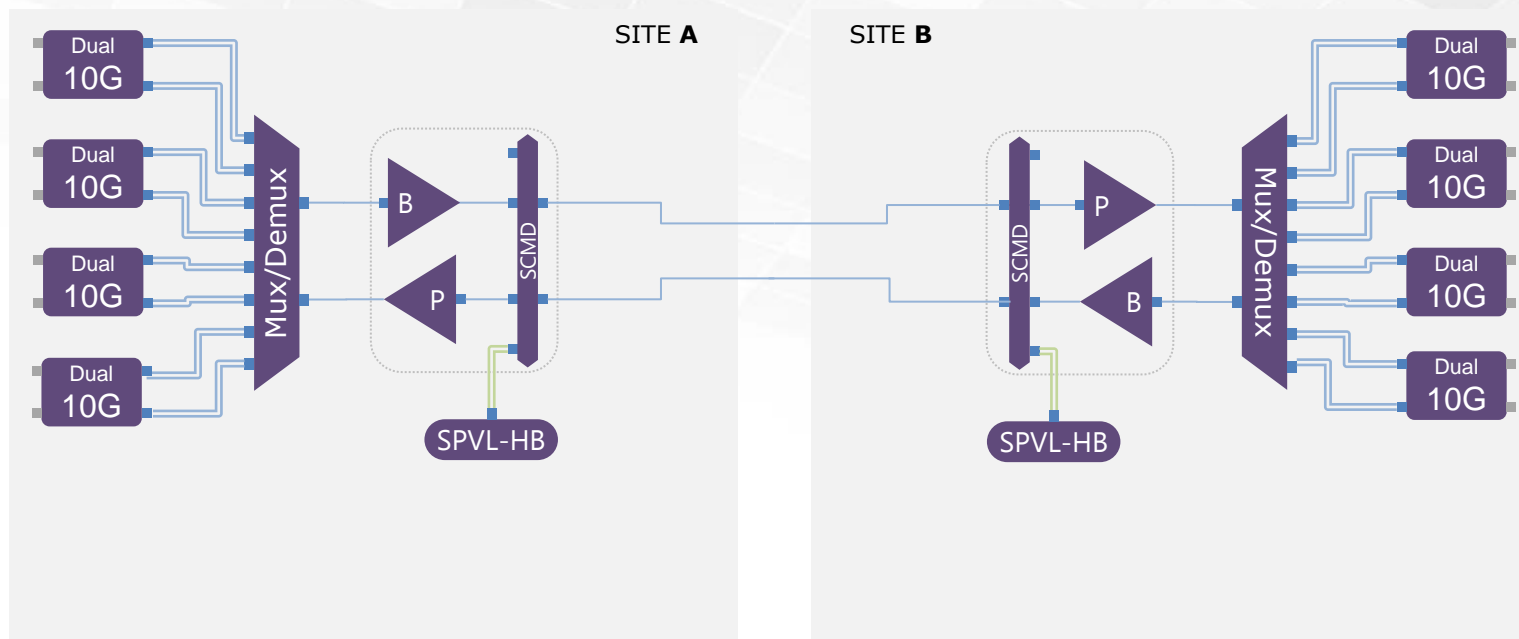

Características	
Alcance (redes Metro)	~80km
N de canais total	8
Capacidade total	80 Gb/s
Ocupação	2U

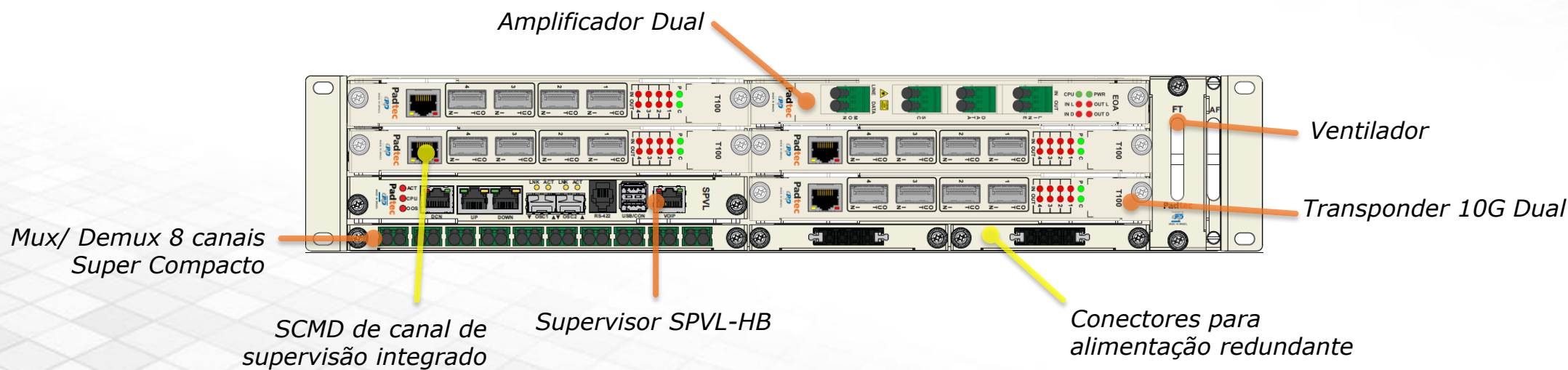

Sistemas ponto a ponto: Proteção de rota 8 canais

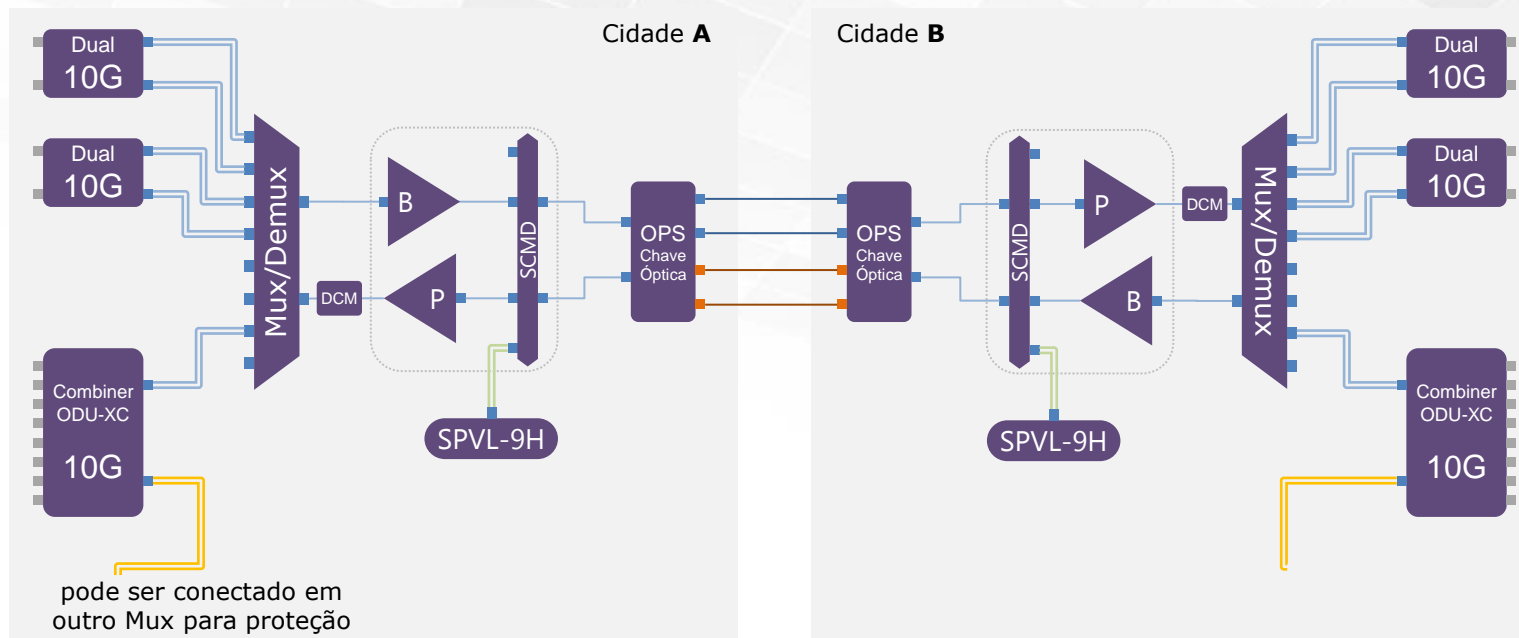

Características	
Alcance (redes Metro)	> 100 km
N de canais iniciais	5
N de canais total	8
Slots utilizados	8
Slots para expansão	2
Capacidade inicial	50 Gb/s
Capacidade total	80 Gb/s
Ocupação	4U
Proteção	de rota

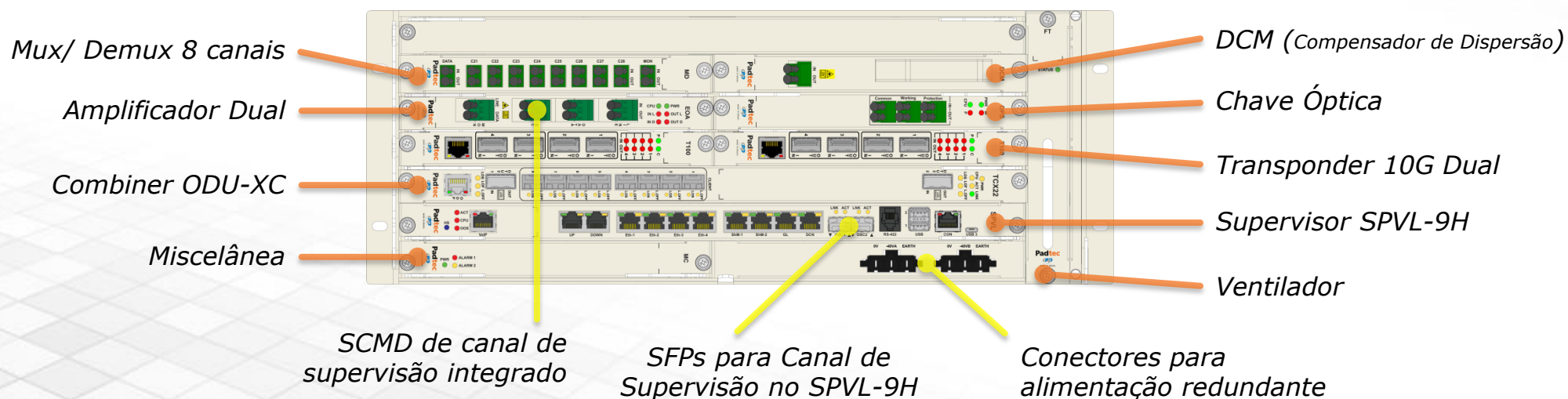

Um pouco sobre nós...

Padtec

Sobre nós...

- Início de operação em 2001
- Maior fabricante de sistemas de transmissão óptica na América Latina
- Portfólio completo de serviços profissionais para redes terrestres e soluções turnkey para sistemas submarinos
- Fornecedor global: equipamentos e soluções vendidos em todos os continentes



Acionistas



O CPqD é responsável pelo mais extenso programa de pesquisa e desenvolvimento em TIC na América Latina, totalmente dedicado a prover soluções para telecomunicações, finanças, energia, entre outras indústrias, tanto no setor privado como público.



A Ideiasnet é uma companhia com ações negociadas na Bovespa, que investe em empresas do setor de Tecnologia, Mídia e Telecomunicações. Atua ativamente em suas investidas na definição de estratégias, no posicionamento de mercado e na estruturação de fusões e aquisições.



BNDESPAR é responsável pela operação de renda variável, realiza investimentos em empresas dos setores prioritários na estratégia do BNDES, como energia renovável, fornecimento de óleo e gás, tecnologia da informação e comunicações, biotecnologia, etanol (segunda geração) e *green technology*.

Padtec S/A - Clientes

Provedores							Integradoras
							
Operadoras						 	
							
							
Governo							
							

Redes Iluminadas

*Mais de 200 mil km
de redes implantadas*

— *Backbones DWDM*

● *Redes Metro em
importantes cidades
latino-americanas*

Sistema Submarino do Cabo Junior (Google)

Projeto *turnkey* tendo a Padtec como contratada responsável por todos os aspectos do projeto e implementação. Uma vez concluído, o cabo será operado pela Google.

- 8 pares de fibras
- Capacidade para 130 canais em cada par
- SLTE: transponders 100G (37,5 GHz)

SP

Santos

Rio de Janeiro

RJ

390 km

CIF Março/2016
RFS Agosto/2017

com repetidores submarinos



Portfólio de Serviços



NOC – Campinas/SP

Gerenciamento de Redes:

- Operação 24x7
- Monitoramento e acionamentos em equipamentos e infraestrutura
- Suporte a ativações
- Relatórios de desempenho
- Mitigação de riscos

Atuação global com qualidade diferenciada a partir de uma equipe de engenharia de O&M com profissionais altamente qualificados e equipamentos de última geração.

Caracterização de Redes:

- Medidas completas
- Localização de trechos críticos
- Ações de recuperação

Implantação de Sistemas:

- Site survey e projeto de instalação
- Instalação e comissionamento
- Documentação

Suporte On-Site:

- Equipes e frotas próprias
- Instrumental de última geração
- Vistorias
- Gestão de sobressalentes

Uma reflexão...

Padtec

Fibras/Rodovias, uma diferença importante...

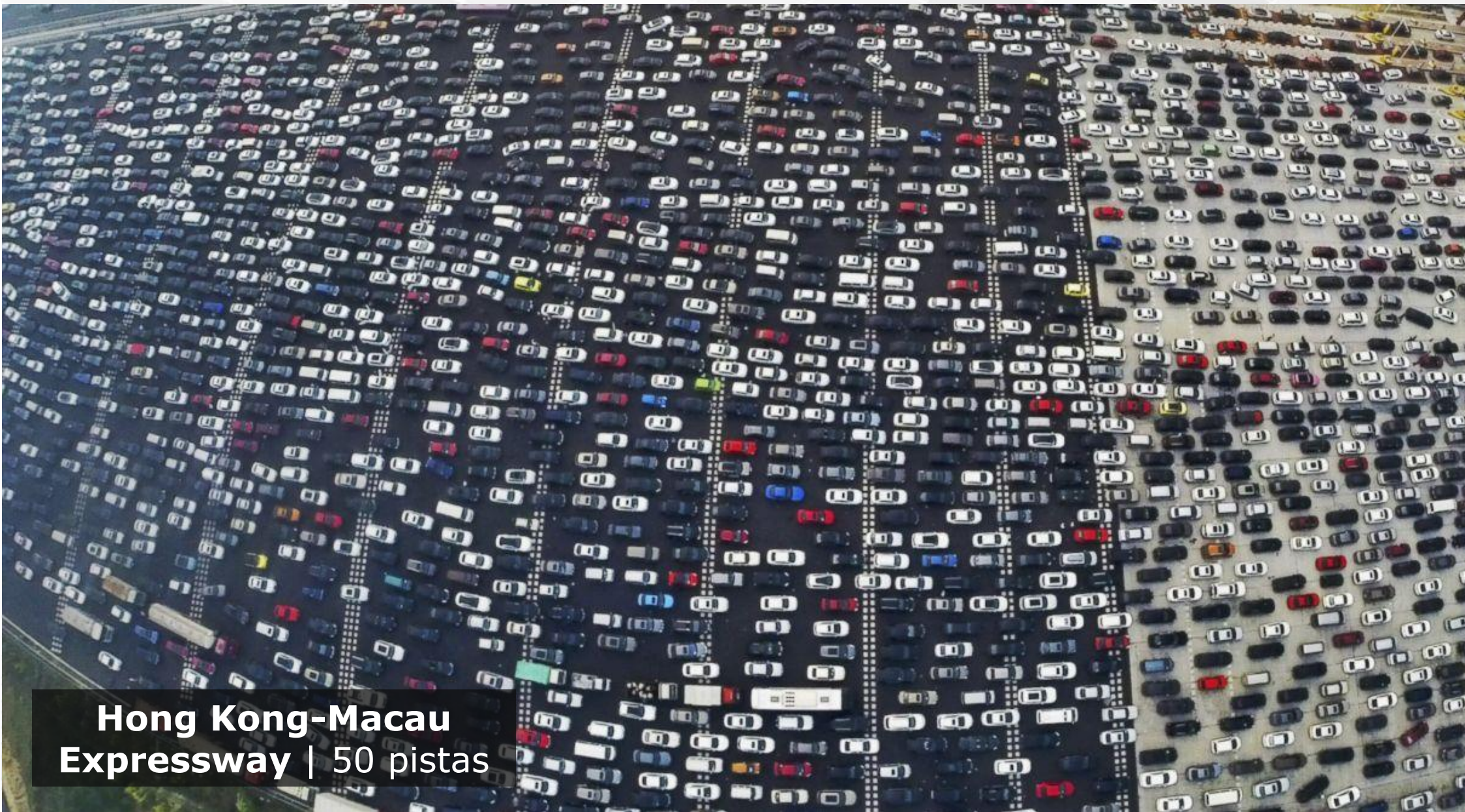

**Hong Kong-Macau
Expressway | 50 pistas**

Padtec



padtec.com