



**FURUKAWA  
ELECTRIC**

**SOLUÇÕES INTELIGENTES PARA REDES FTTx**

# Como reduzir o investimento (CAPEX) da minha rede?



**PROJETO  
EFICIENTE**



**INOVAÇÃO  
TECNOLÓGICA**

# FTTH Atual

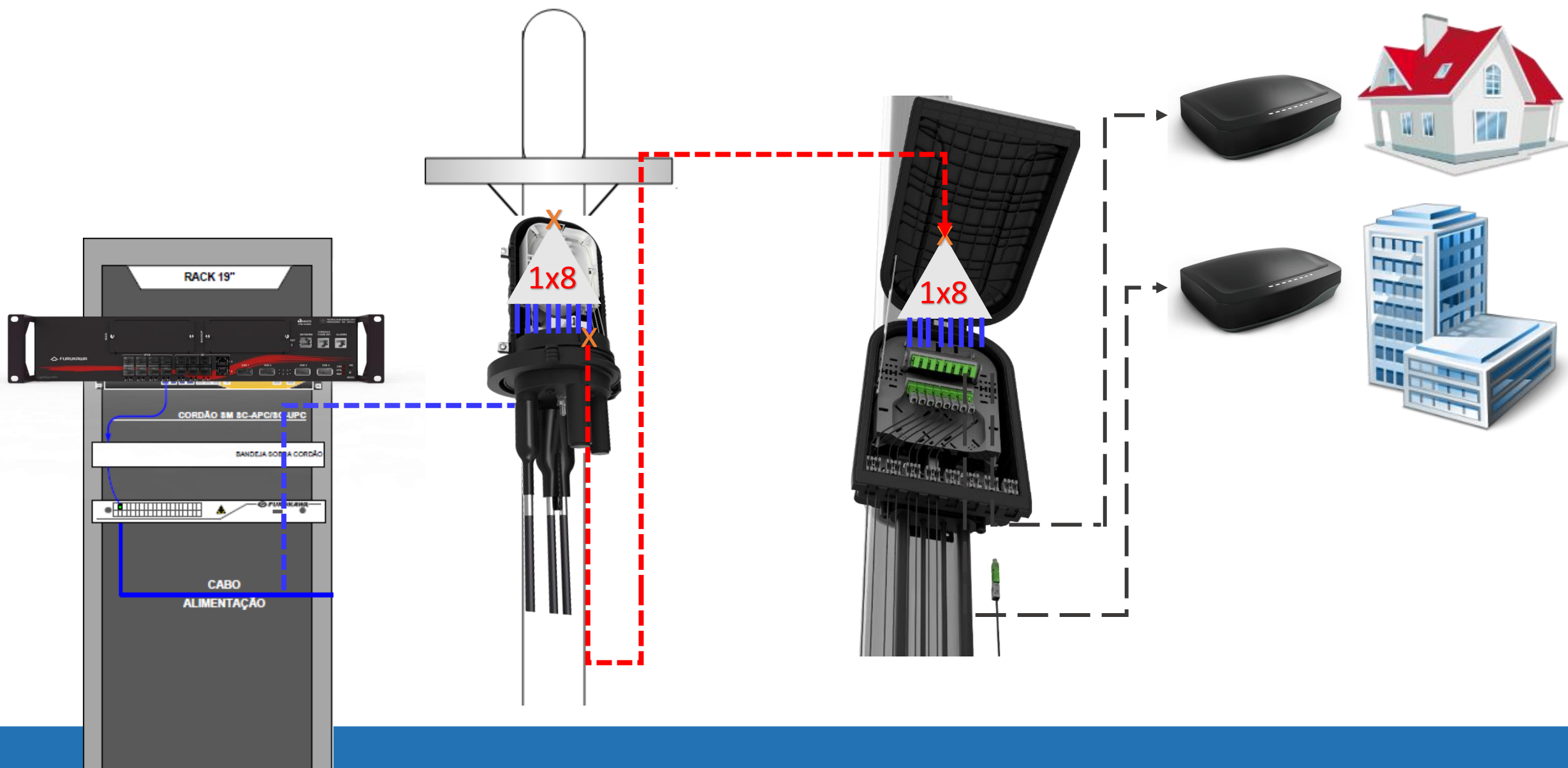

# Planejamento

## FTTH Atual

- 1 Determinar taxa de penetração
- 2 Definir splitter de atendimento (2º nível)
- 3 Delimitar células lógicas (64 usuários)
- 4 Posicionar CTO's
- 5 Posicionar CEO's (splitter 1º nível)
- 6 Dimensionar e traçar rota do cabo troncal
- 7 Dimensionar e traçar rota do cabo de distribuição



CENTRAL – SAÍDA DE CABOS



SPLITTER DE 1º NÍVEL - 1x8 NC/NC **CEO**



SPLITTER DE 2º NÍVEL – 1x8 NC/SC-APC **CTO**

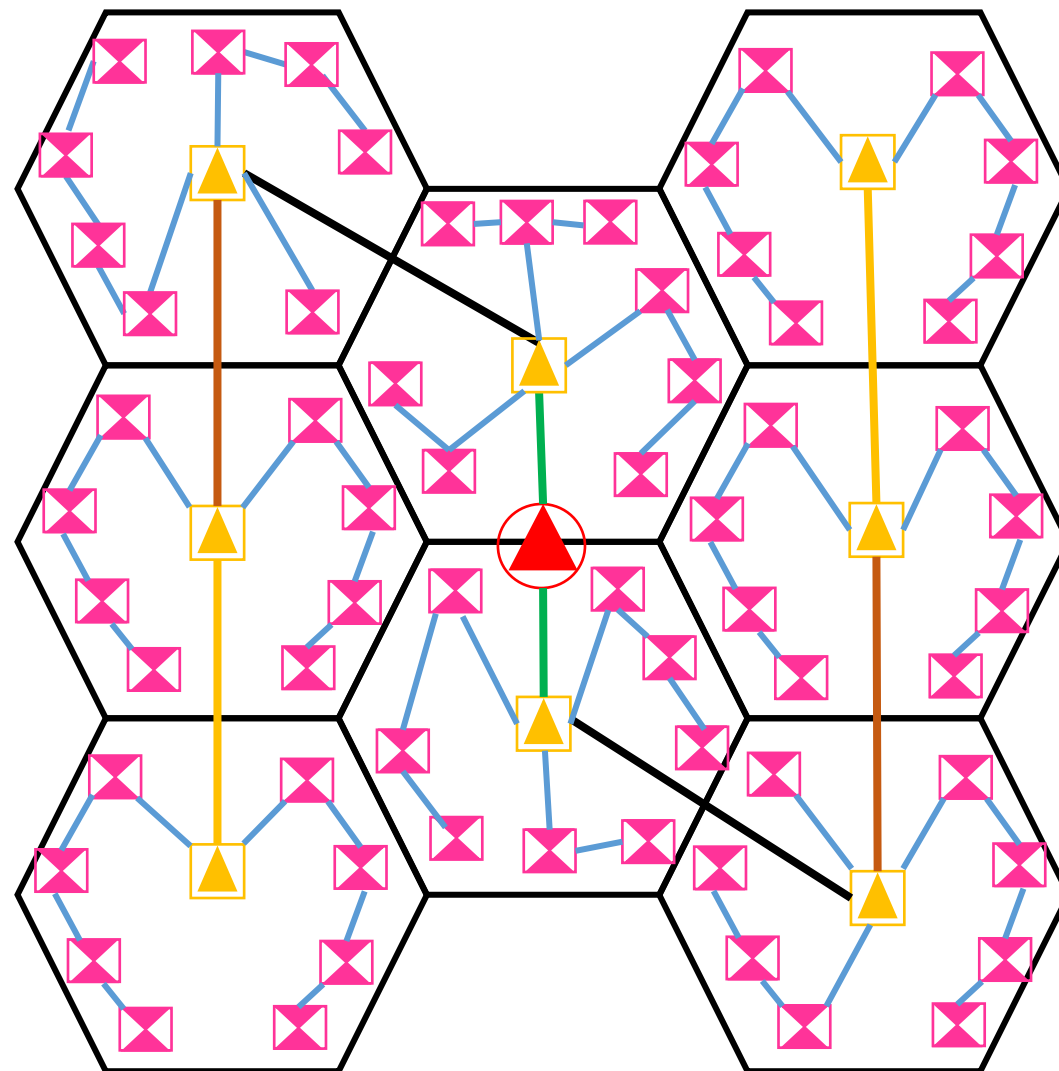

# Solução Ez!Lux FTTH

Redução  
de CAPEX

Investimento  
sob demanda

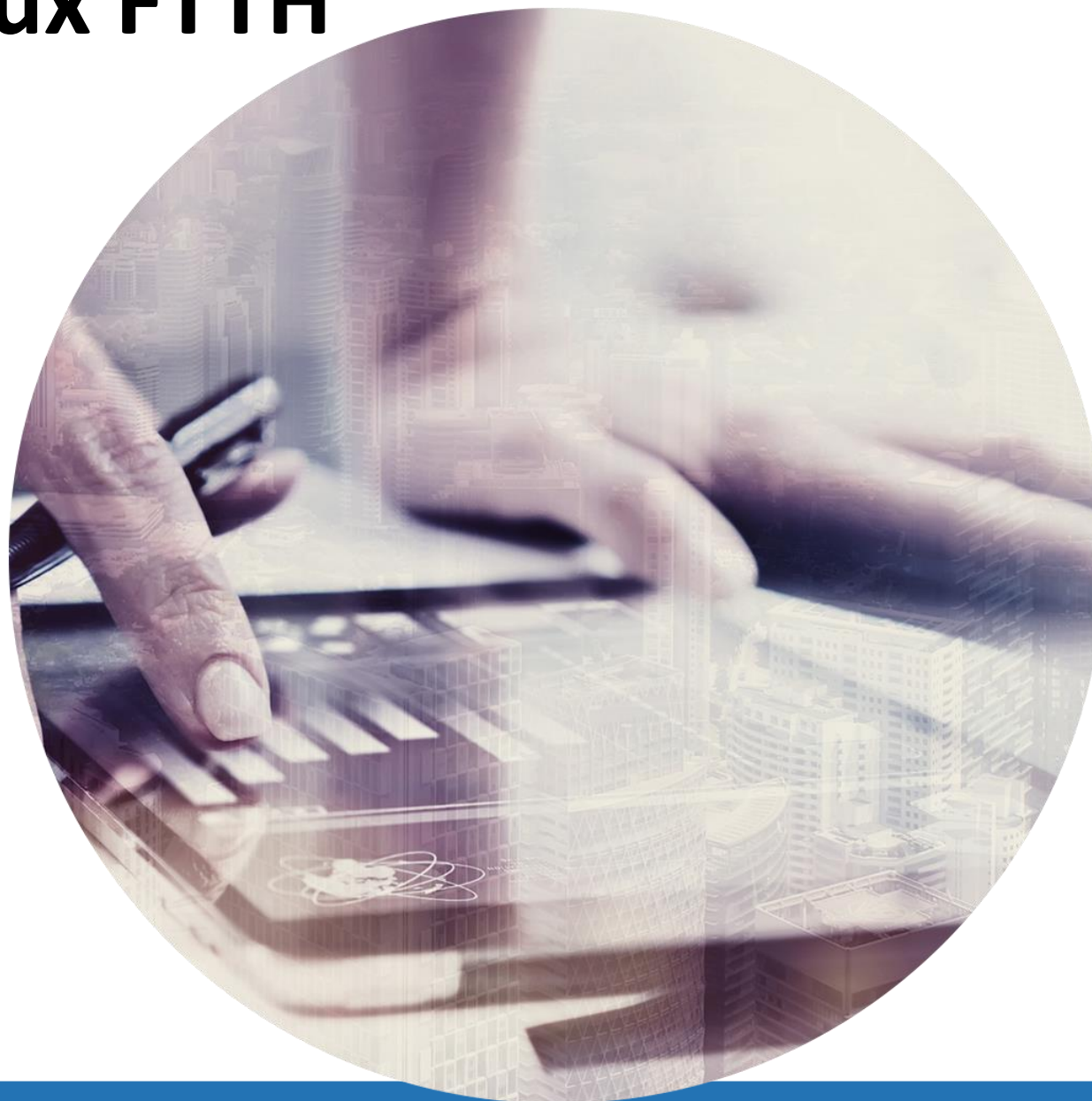

Modularidade

Flexibilidade

Agilidade

Segurança

Economia

# Ez!Lux FTTH

## Tecnologia Pré-Conectorizada

Ativação rápida sem abertura da caixa

Conector seguro e reforçado IP 68

16 conexões – assinantes ou  
CTOP-L (extensão)

96 fusões

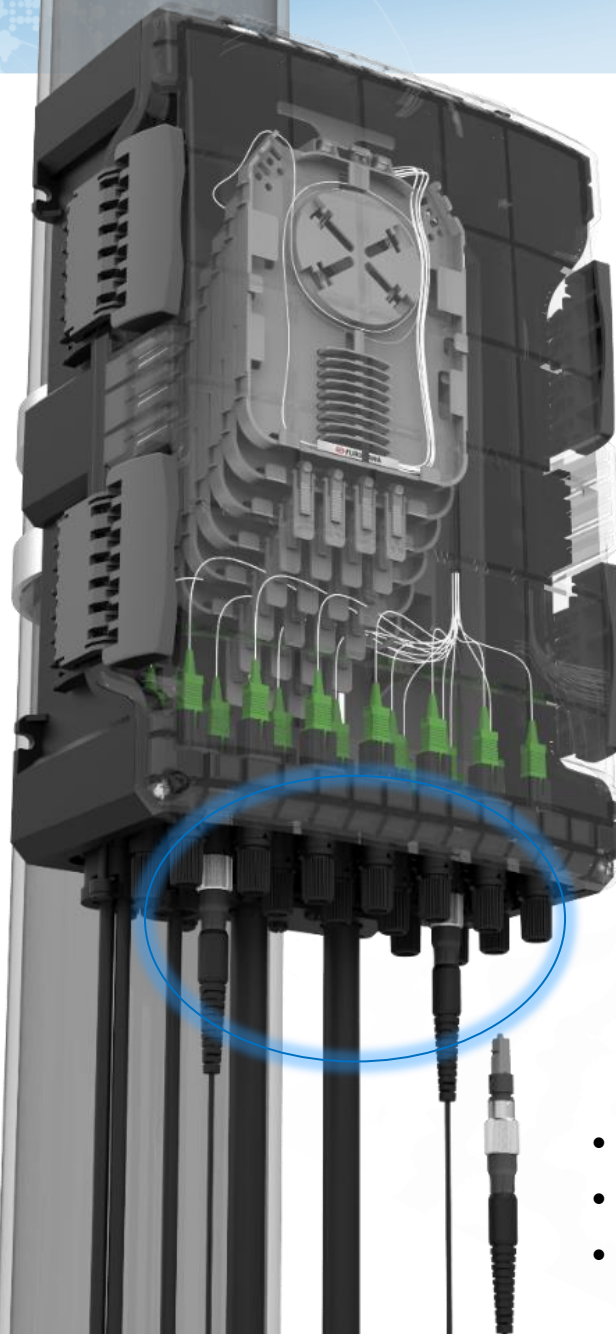

**CTOP**



**SLIMCONNECTOR**



**CTOP-L**



- CAIXA SELADA
- PRÉ-CONECTORIZADA
- SPLITTER 1X8

# Ez!Lux FTTH

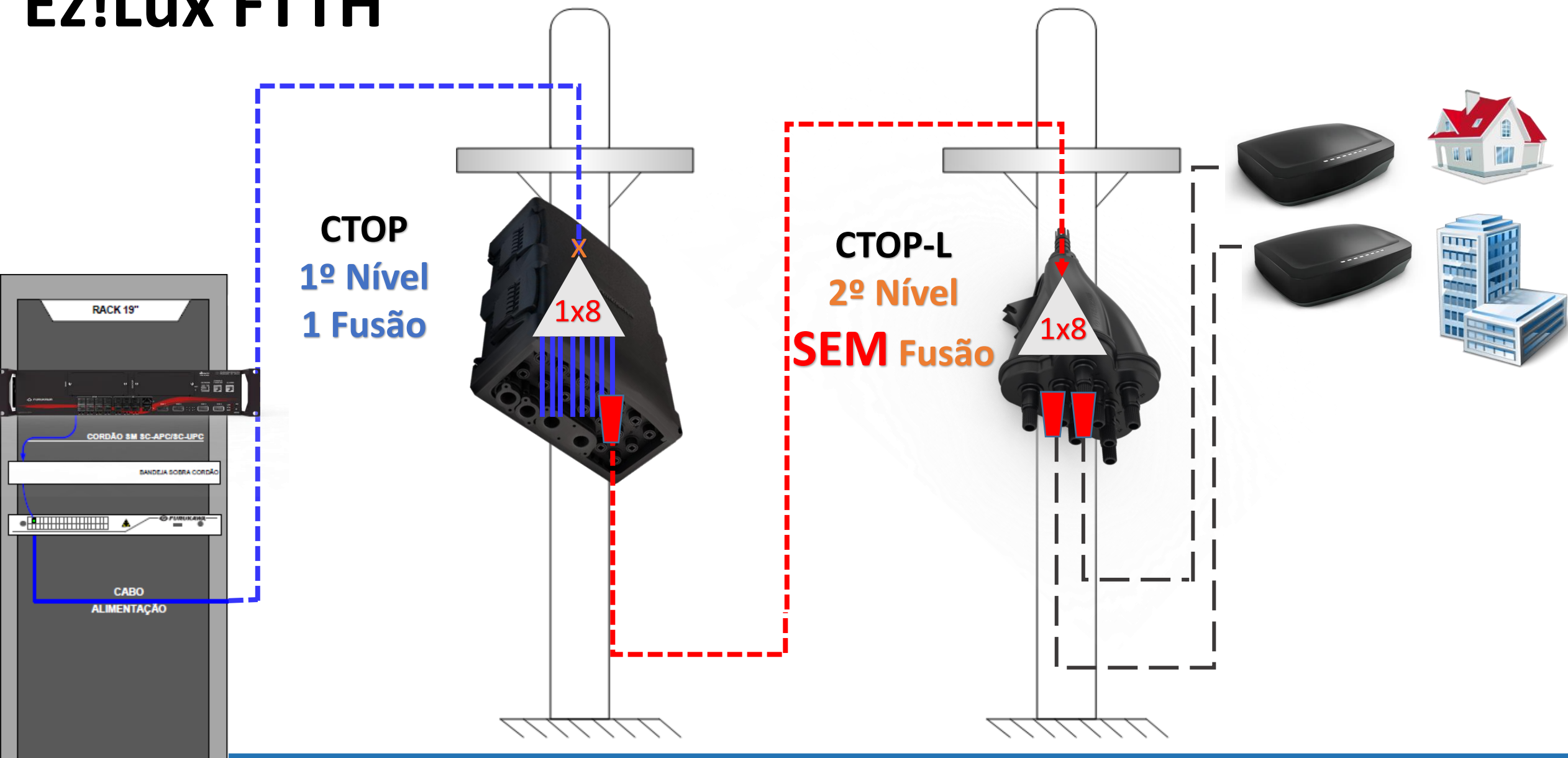

# Ez!Lux FTTH

**CTOP**

*Caixa de Distribuição  
Rede Troncal Principal*

*Extensão  
Rede de Distribuição*

**CTOP-L**



**SLIMCONNECTOR**



**AS80 4.6MM 01F**

*Acesso ao  
Assinante*



**DROP COMPACTO +  
SLIMCONNECTOR**

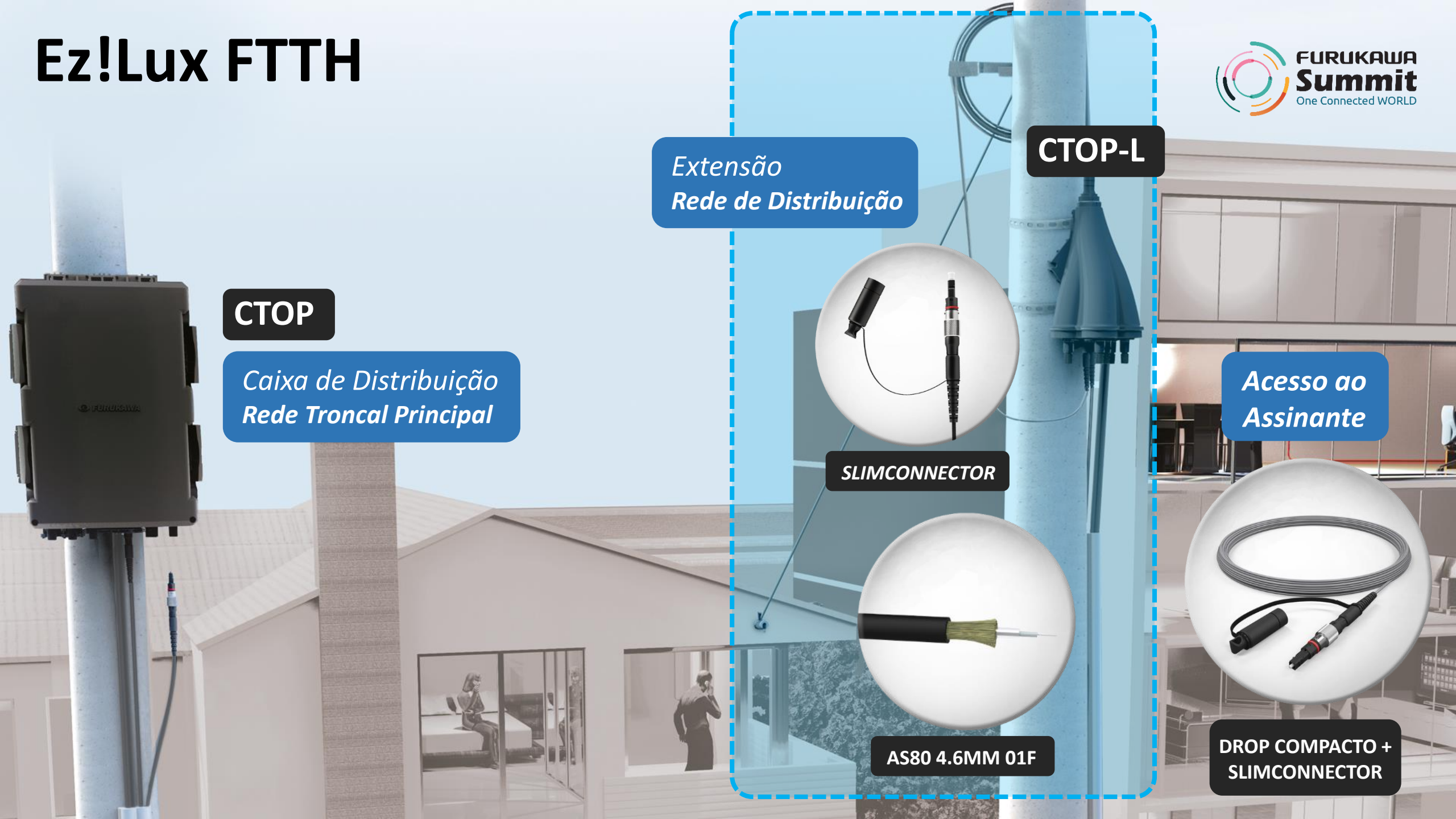



# Ez!Lux FTTH

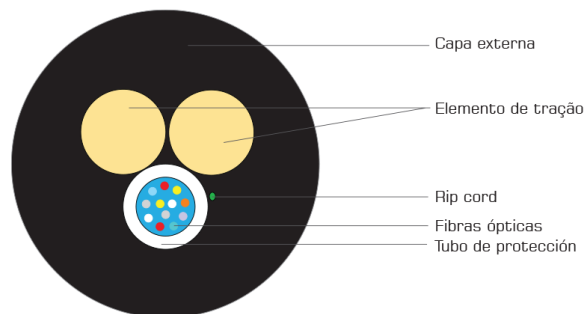

CFOA-X-AS120-RA 12 FIBRAS

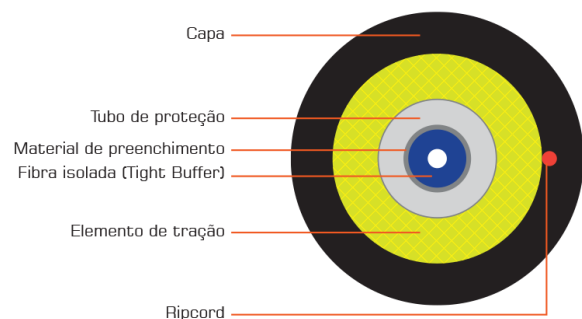

## Comparativo MINI-RA, AS80 01F e Drop Compacto

Tipo de Cabo	Peso (kg/km)	Dimensões	Carga máxima de operação (CMO)
AS80 MINI-RA (ASU)	42	6,8 mm	1250 N
AS80 01F	<b>23</b>	4,6 mm	<b>1000 N</b>
DROP COMPACTO	20	5,0 x 2,0 mm	660 N







# Ez!Lux FTTH

## Pontos principais

Uma fusão na REDE EXTERNA  
No 1º nível - **CTOP**

CAPEX das caixas de atendimento  
SOB DEMANDA

EXPANSÃO de rede 100%  
PRÉ-CONECTORIZADA

-  CENTRAL – SAÍDA DE CABOS
-  SPLITTER DE 1º NÍVEL - 1x8 NC/SC-APC **CTOP**
-  SPLITTER DE 2º NÍVEL – 1x8 **CTOP-L**

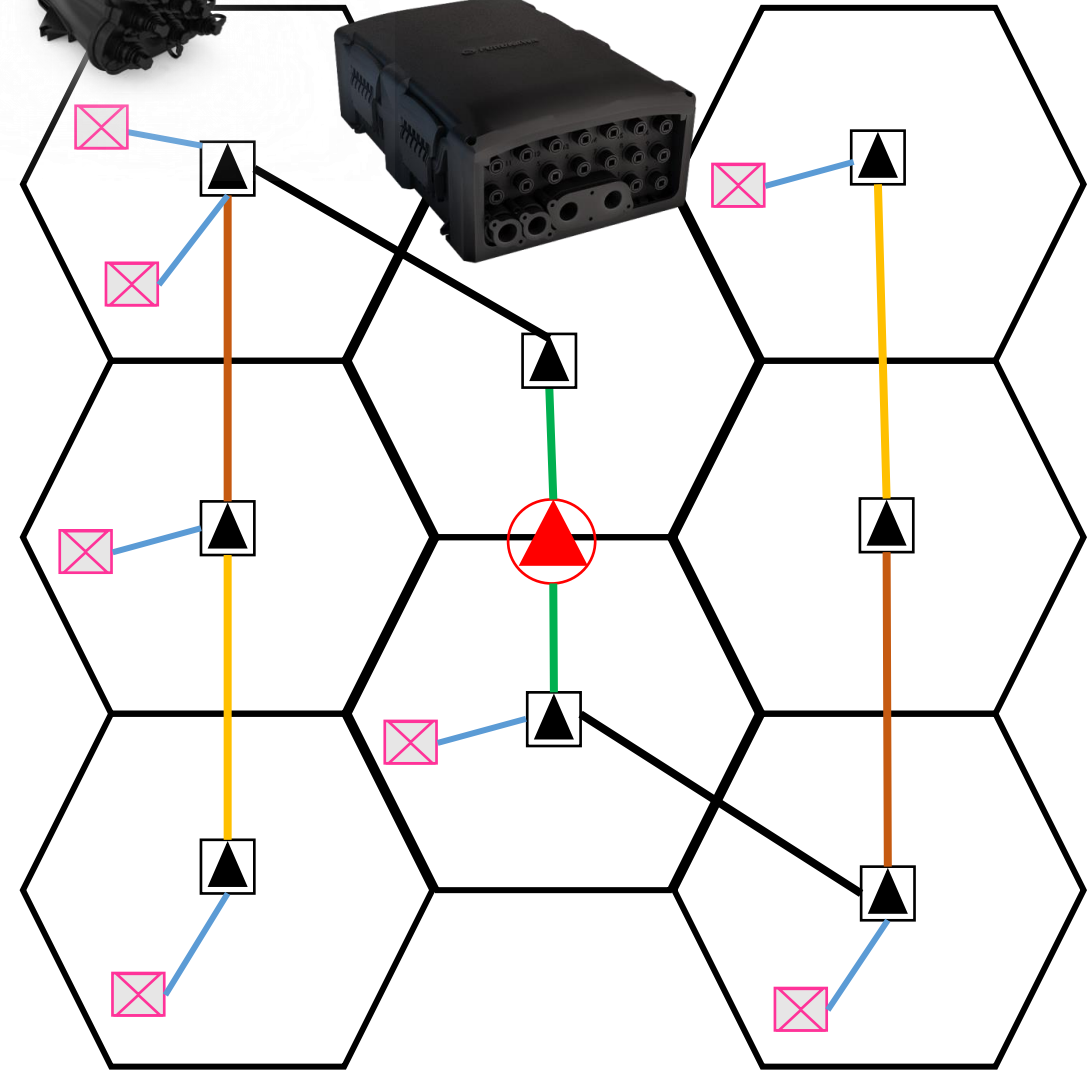

# Ez!Lux FTTH

## *Impacto econômico*

Redução de **63%** em serviço de lançamento de cabo.

Elimina ferrugem na Rede de Distribuição.

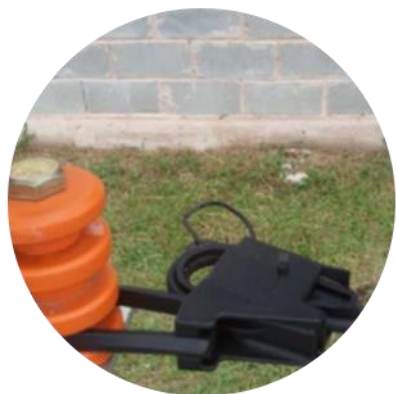

Cabo 01F 4.6mm  
**DISTRIBUIÇÃO**

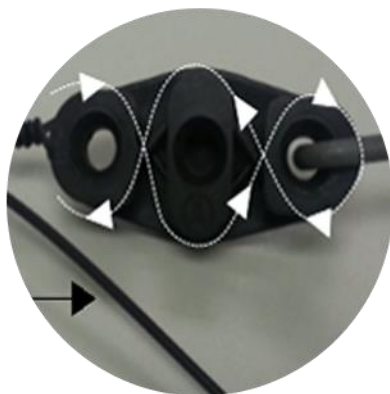

Drop compacto  
**ACESSO**

**Esticador  
Plástico**



# Ez!Lux FTTH

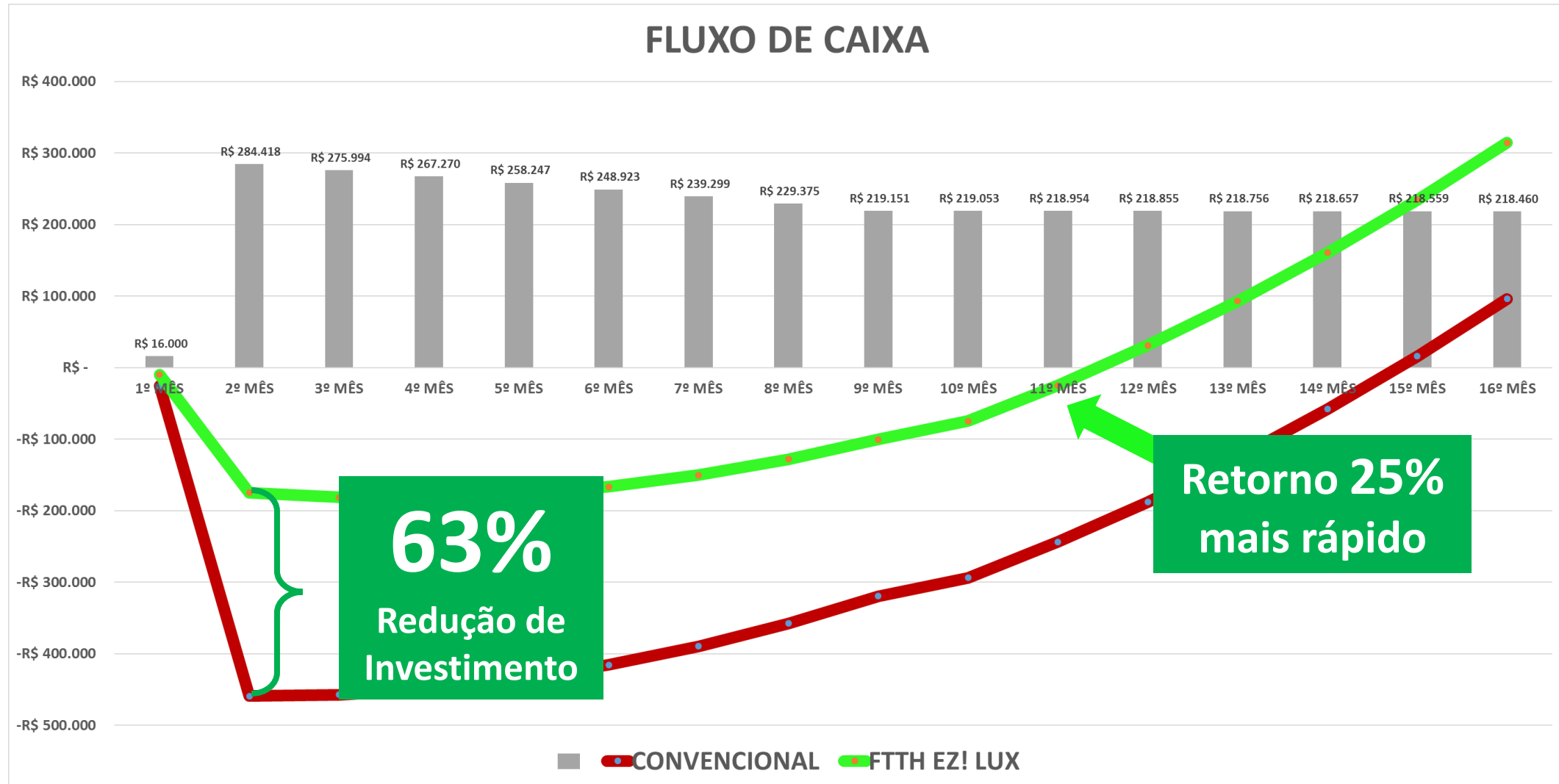

# FTTA Atual | *Splitters na base*

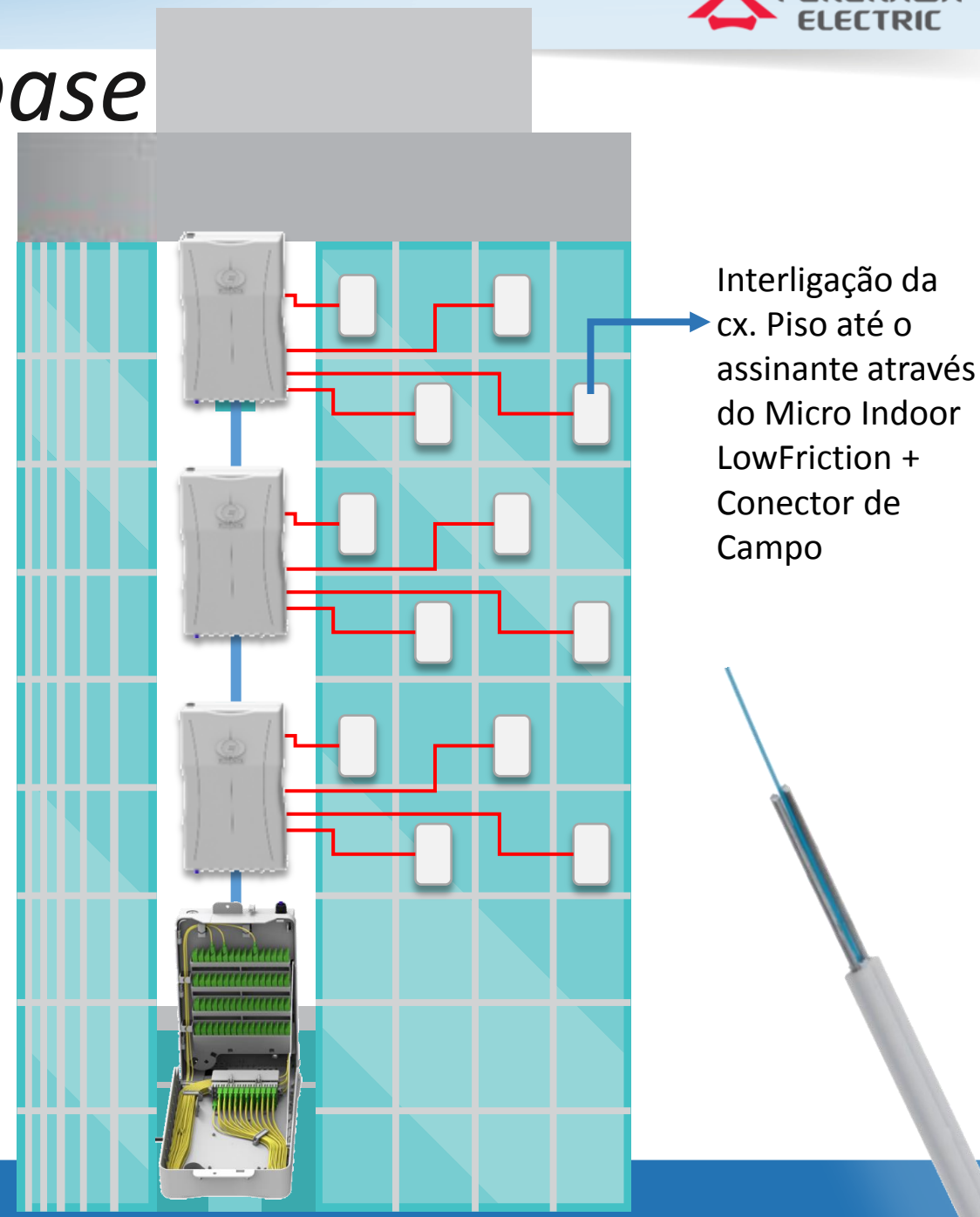
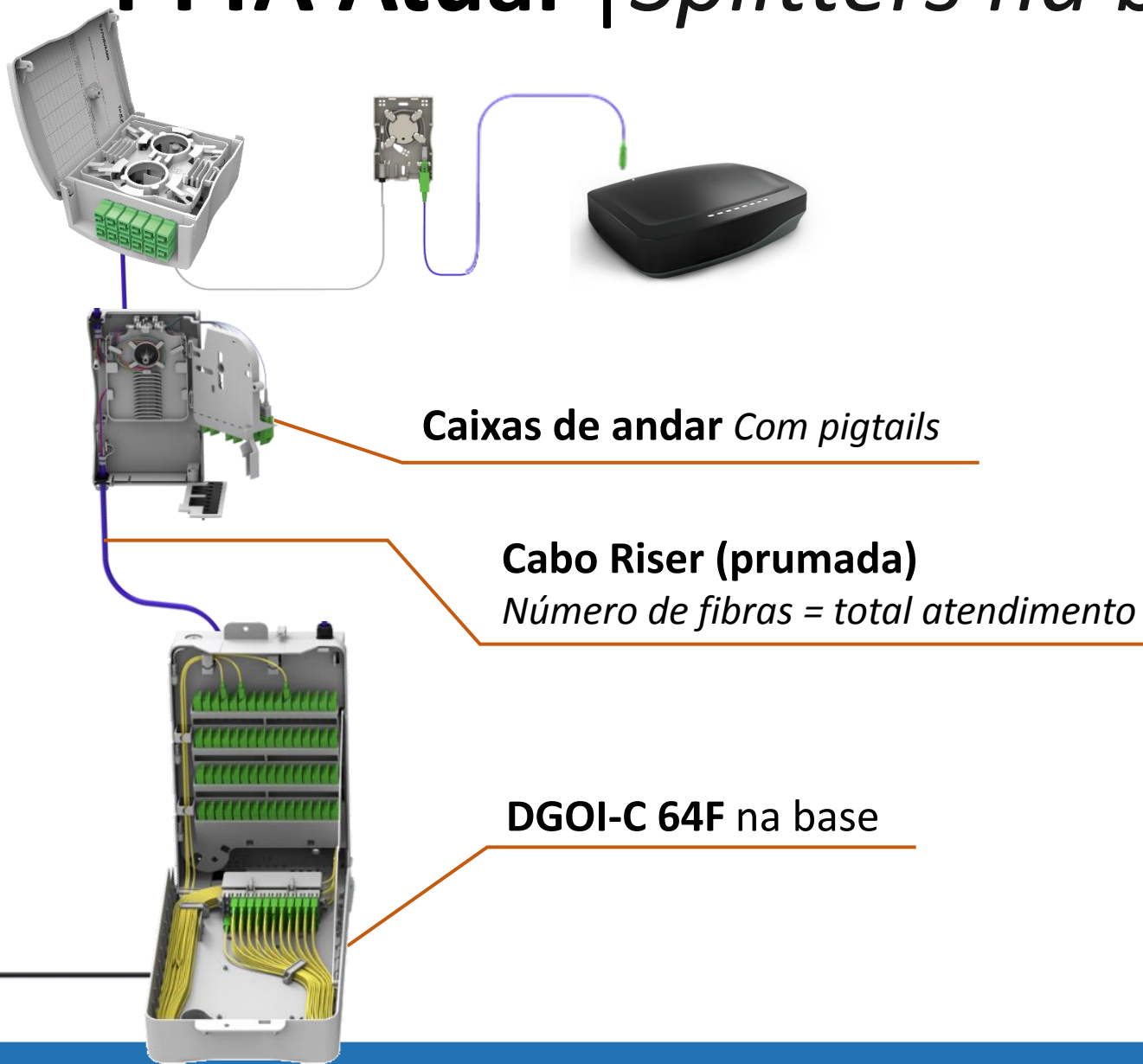

# FTTA Atual | *Splitters distribuídos*

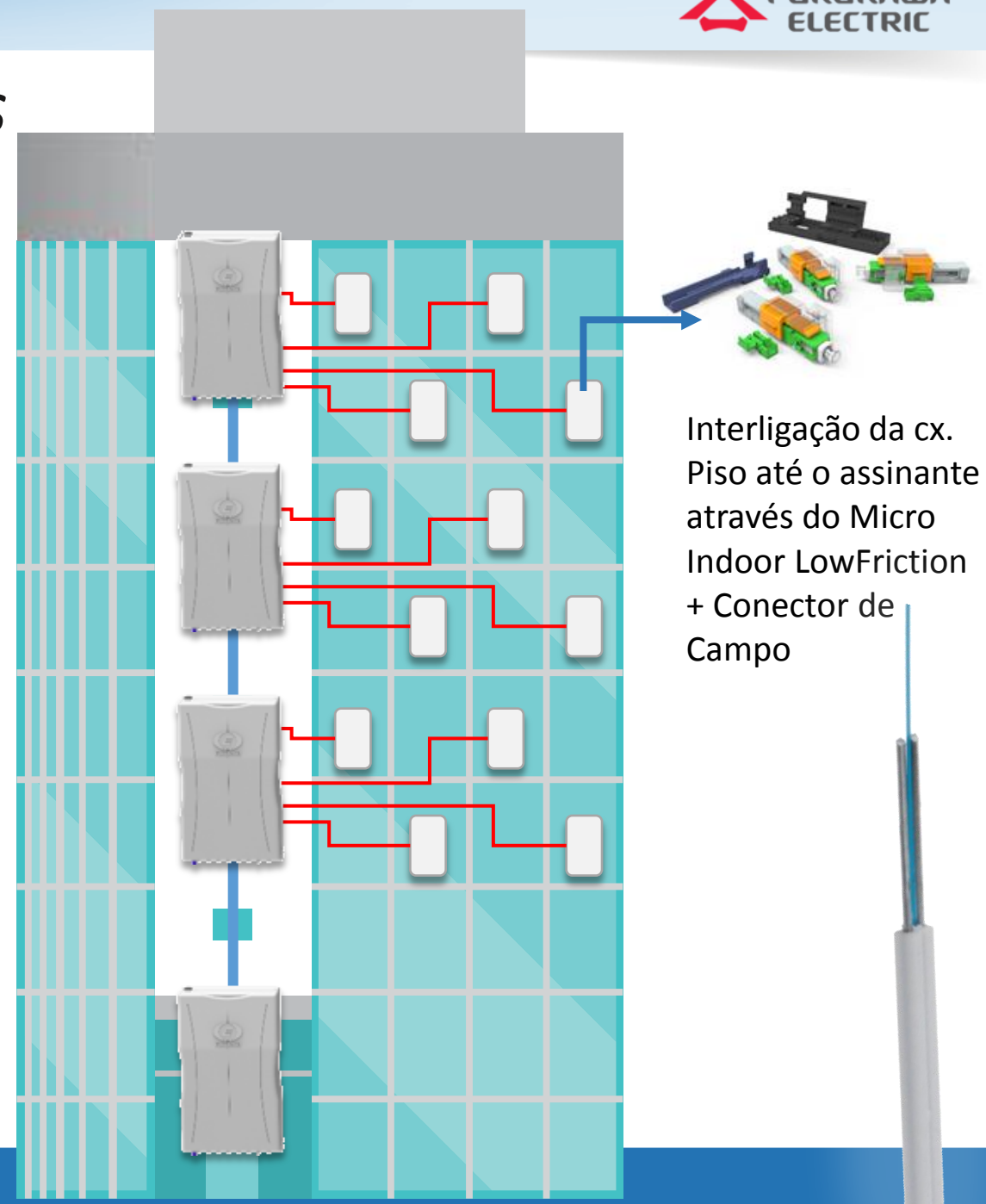
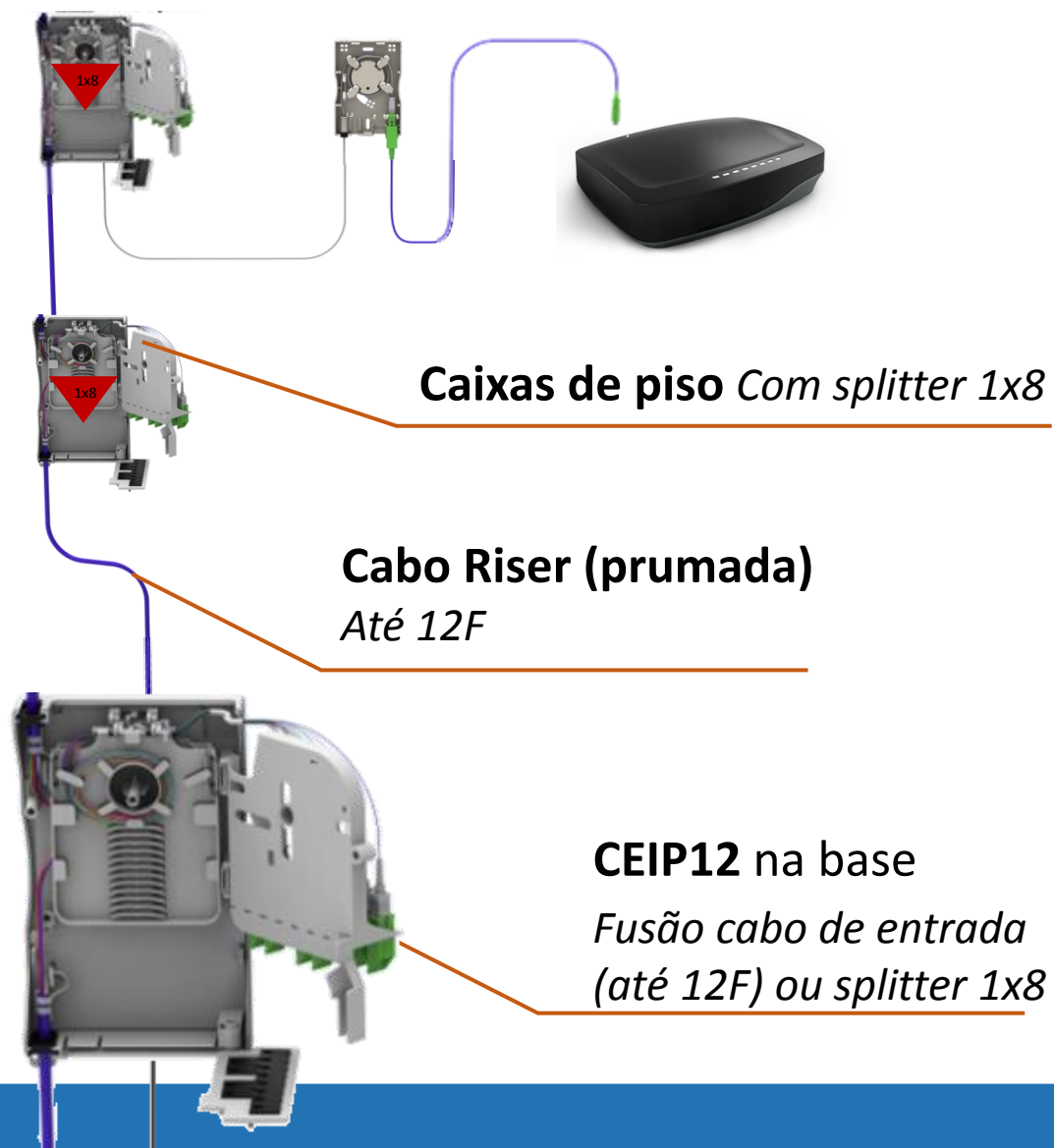

# FTTA Atual

## Splitters centralizados

### Vantagem

Flexibilidade nas manobras sem necessidade de previsão exata da demanda.

### Desvantagem

Alto custo.

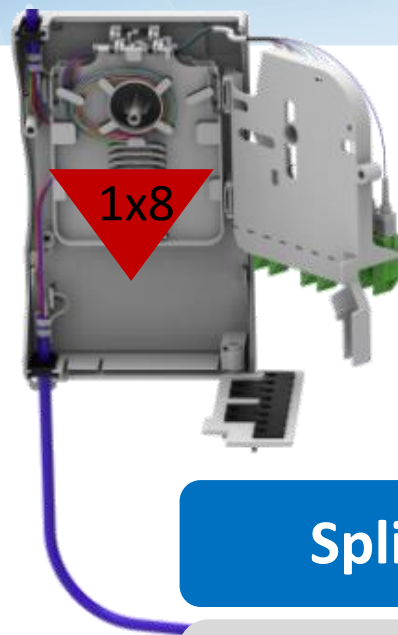
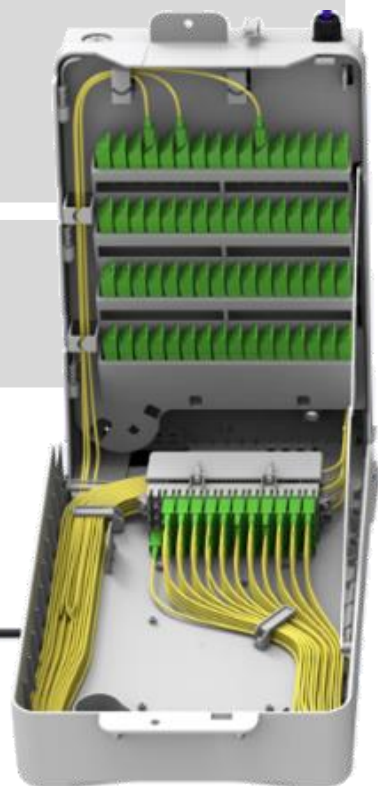

## Splitters distribuídos

### Vantagem

Redução de custo.

### Desvantagem

Splitters ociosos.

*Como aliar redução de investimento inicial e ociosidade de splitters?*

# EZ!Lux FTTA

*Atendimento  
ao 1º assinante*



*Precisou de mais?*



*Expansão  
Plug and Play*



## **FiberLan EZ!Lux FTTA**

*Cabo de prumada interno,  
com fibras 0.9mm, de fácil  
sangria nas caixas de andar*





# EZ!Lux FTTA

## *Roseta FLEX*



**Caixa de andar com limitador para reserva de espaço**



**Ponto de terminação**

# EZ!Lux FTTA

## CEIP FLEX



**Módulo de expansão com splitter 1x8**

# EZ!Lux FTTA

## *Instalação (HP)*

CEIP 12  
(Módulo Básico)



# EZ!Lux FTTA

*Ativação  
1º Assinante*



**CEIP 12 (Módulo Básico)**



# EZ!Lux FTTA

*Ativação  
2º Assinante*

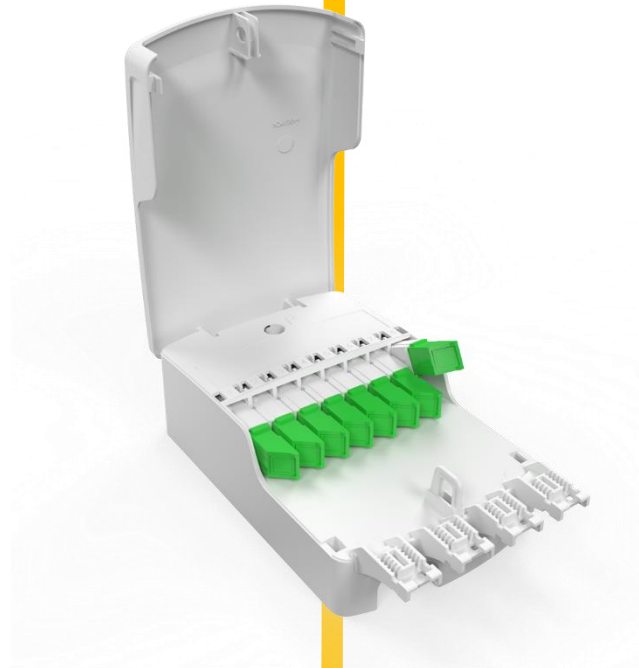

**CEIP 12 (Módulo Básico)**



# EZ!Lux FTTA

## *Cabo Riser Fiberlan EZ!Lux*

### *Para fazer a sangria das fibras*

- 1** Abra uma pequena janela no cabo no piso da caixa óptica (B).
- 2** Corte a fibra desejada.
- 3** Abra uma pequena janela no cabo no piso da caixa (A).
- 4** No piso da caixa óptica (A) puxe a fibra cortada para fazer a conexão na Roseta Flex.

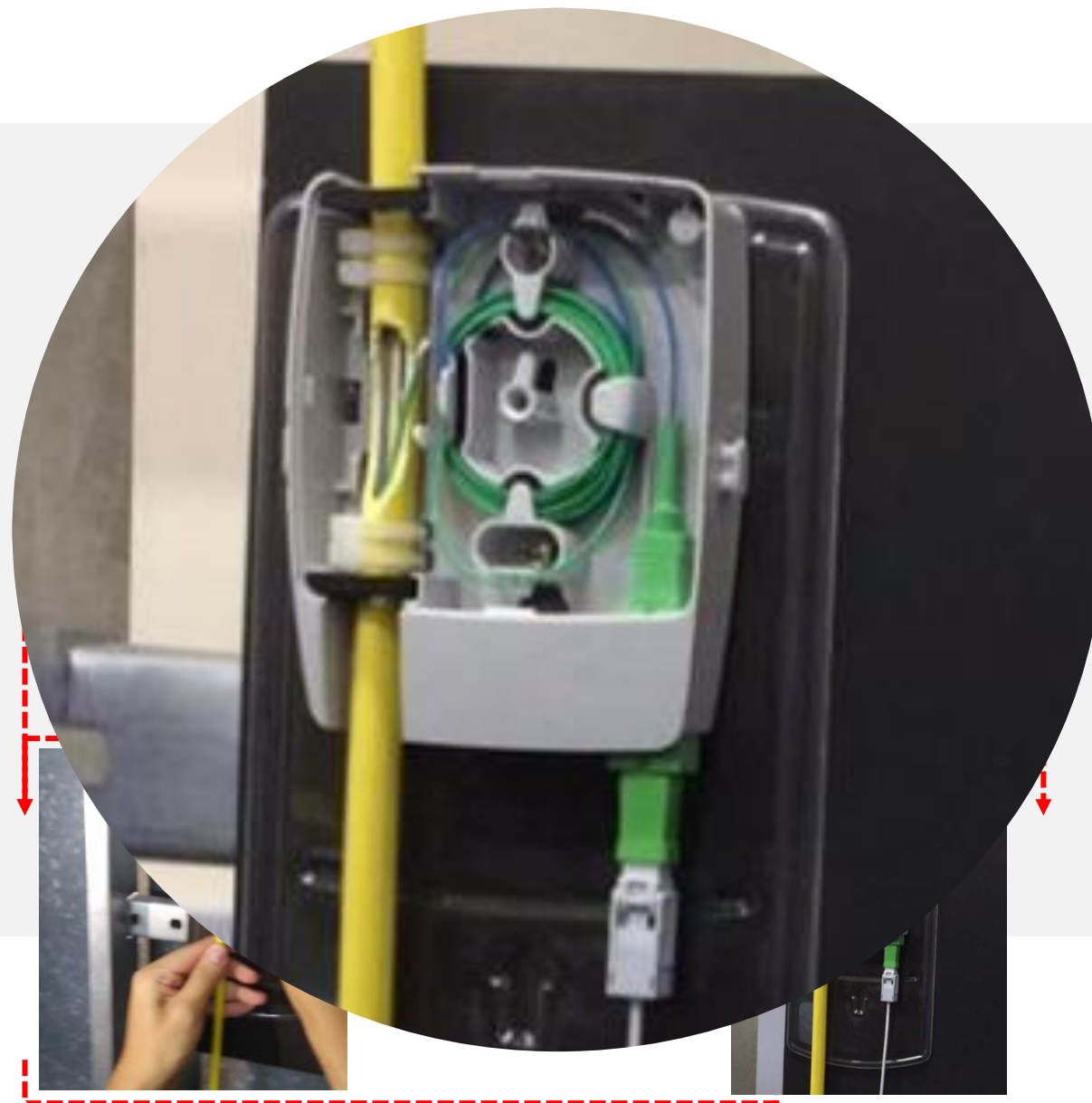

# EZ!Lux FTTA



**CEIP12**, por fusão com até 12F na entrada da base do edifício.

Cabo riser **FIBERLAN EZ!LUX** até 12F.

**Rosetas FLEX** com expansão para até 8 assinantes.

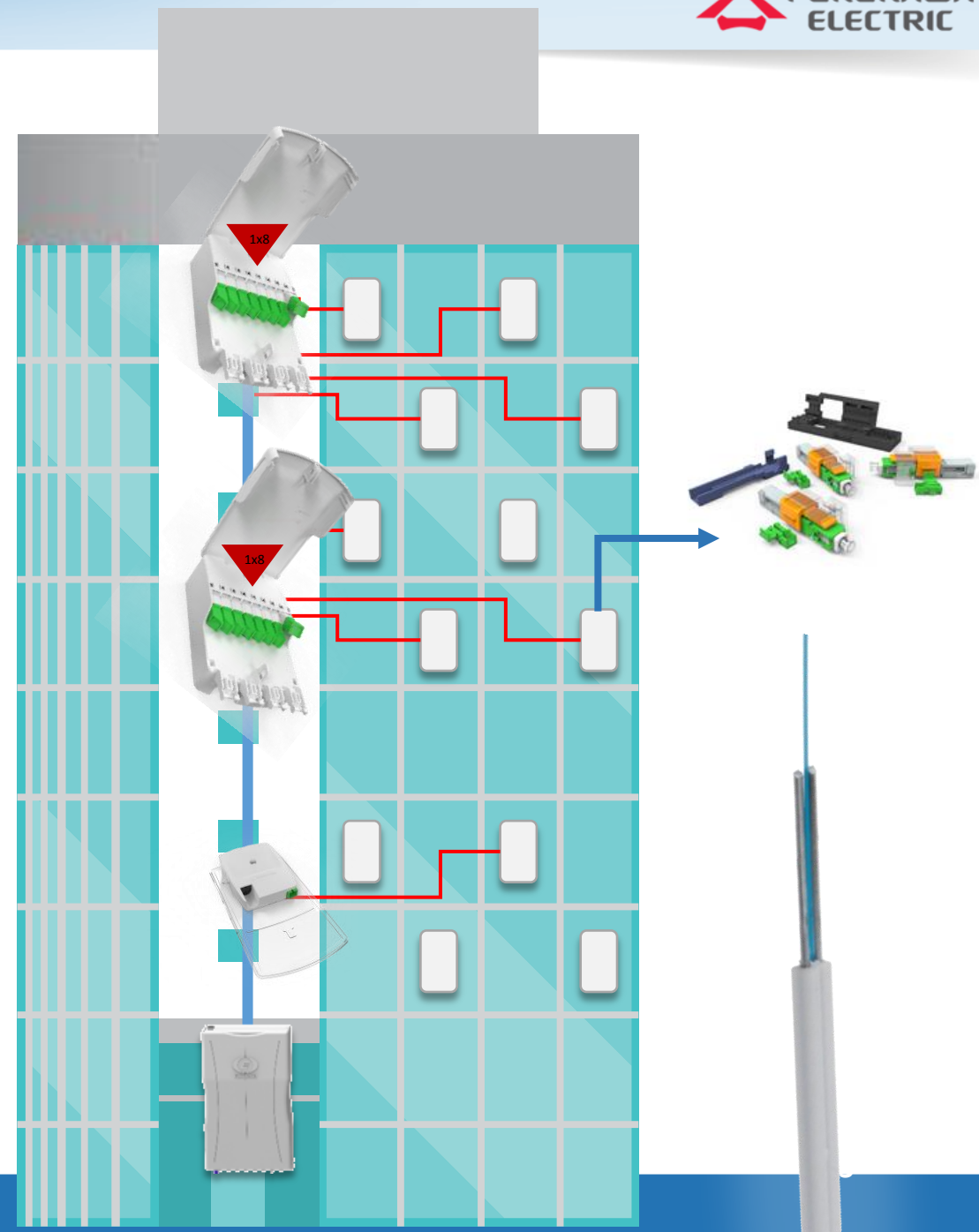

# EZ!Lux FTTA

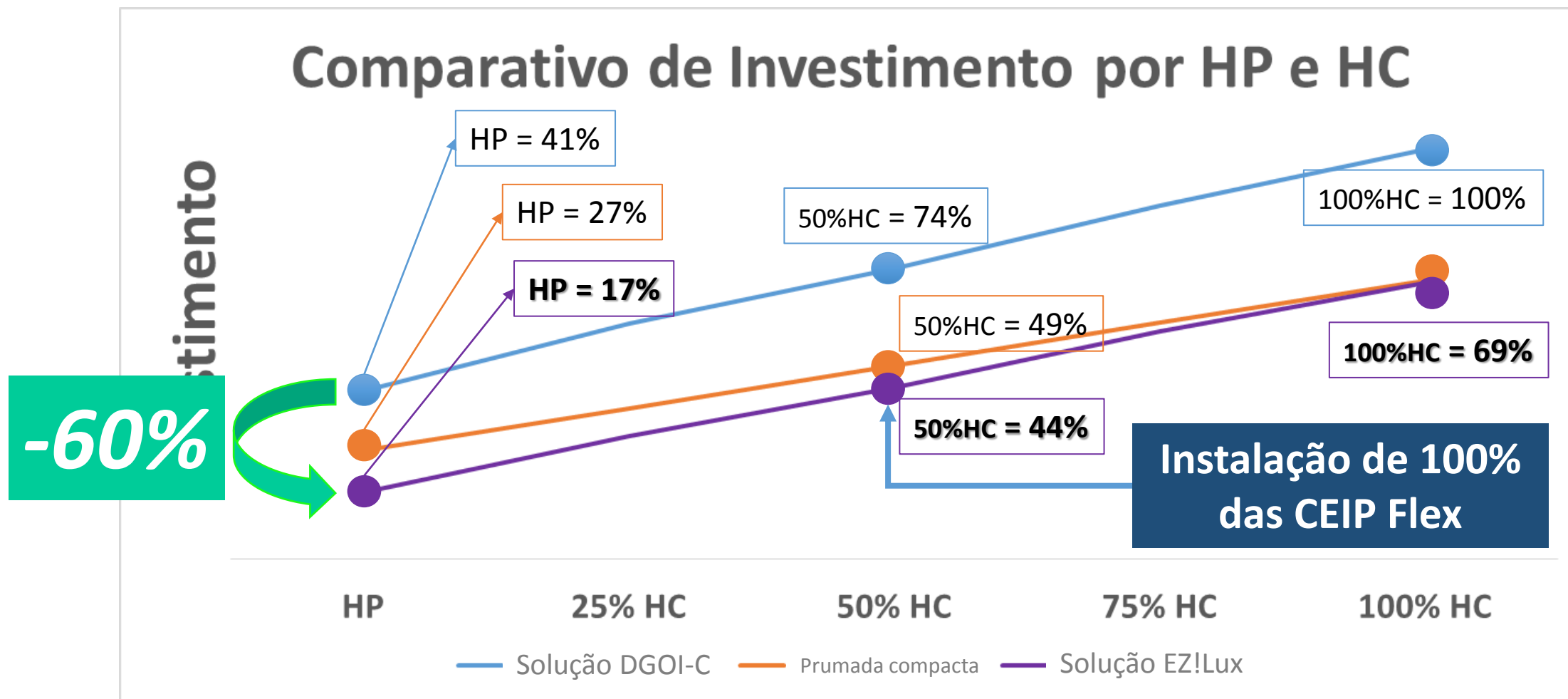



# EZ!Lux FTTA

*Custo*

*Ociosidade*



*Cobertura*

*Clientes*

*Receita*



**Obrigado!**